

This page needed for MD-20024 & MD-20025 only.

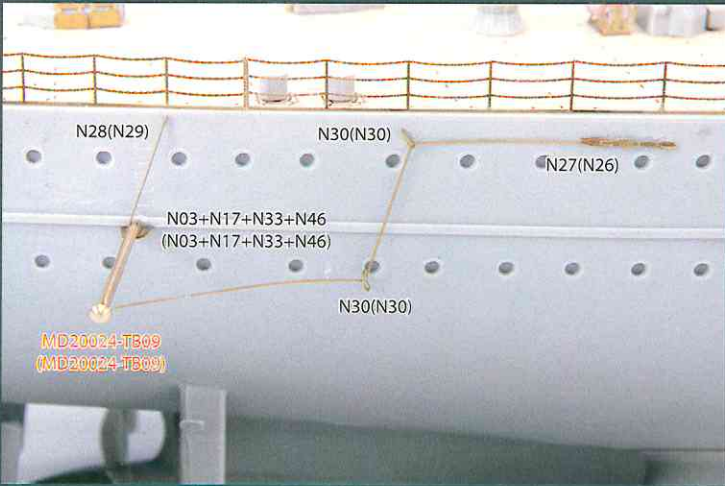

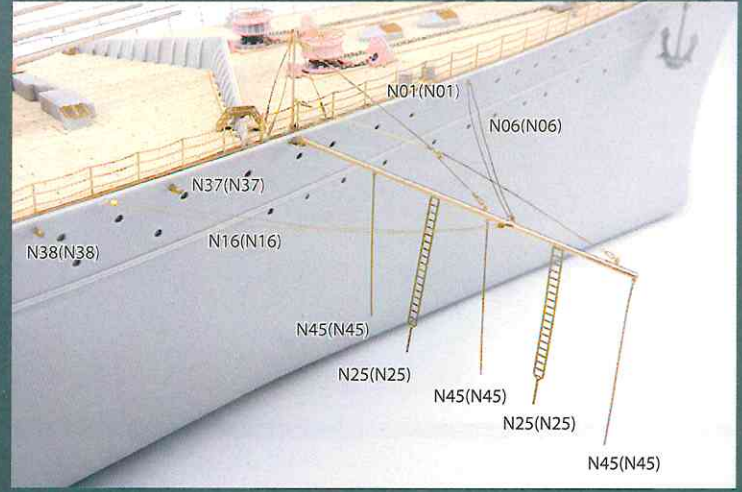
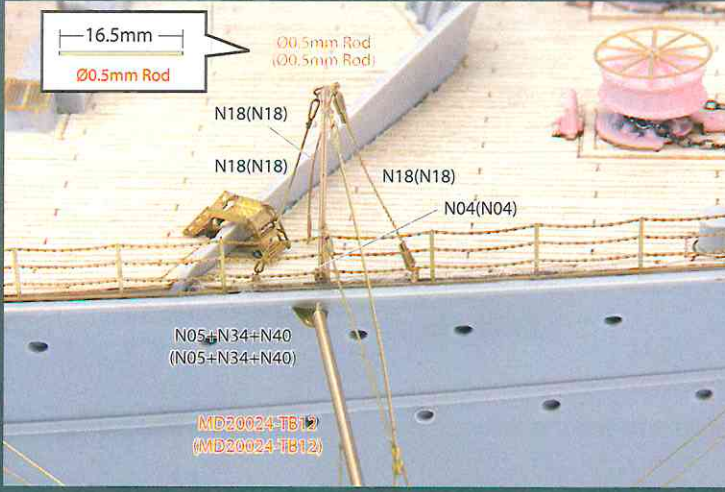
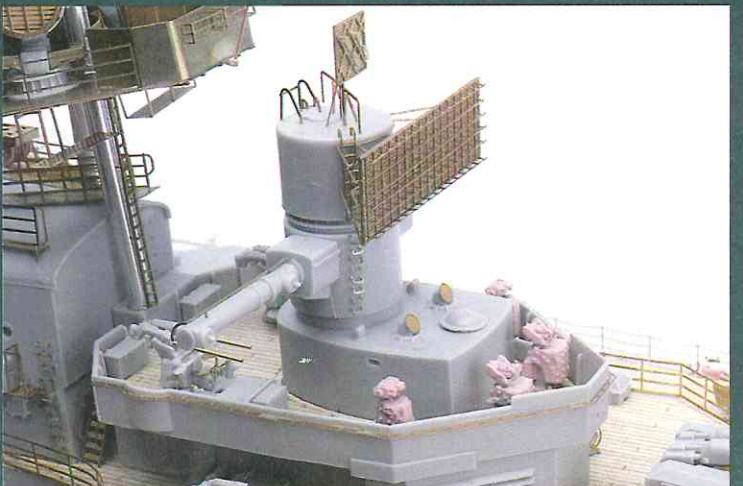
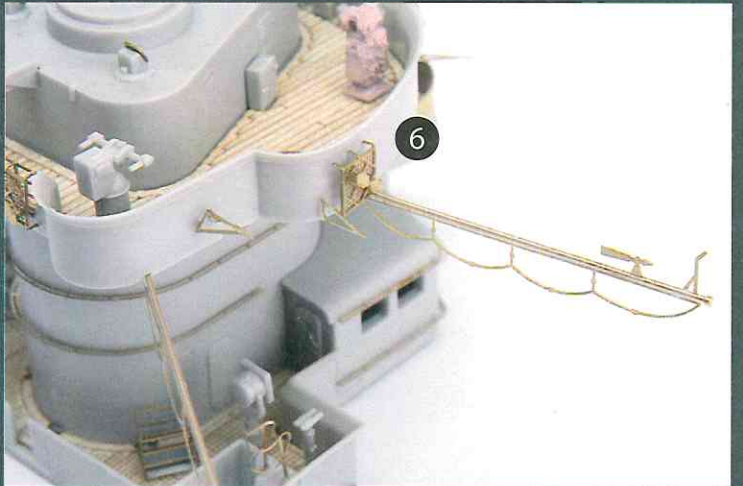
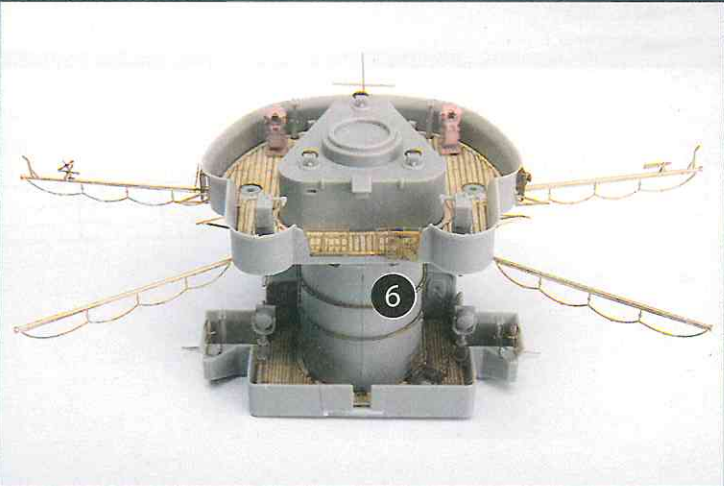
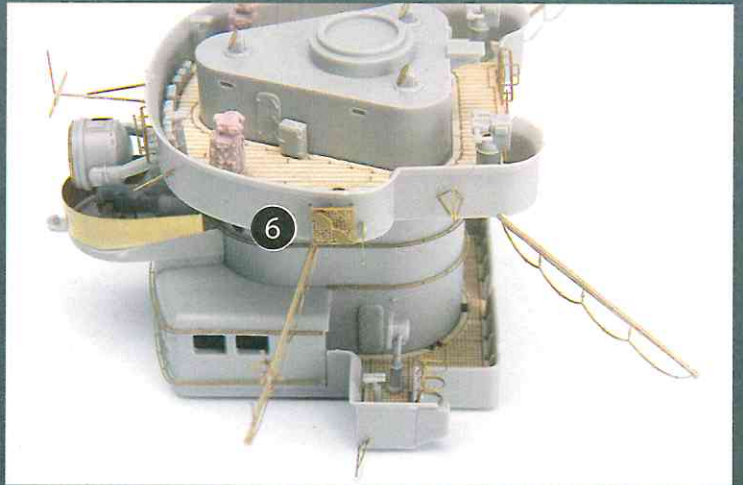
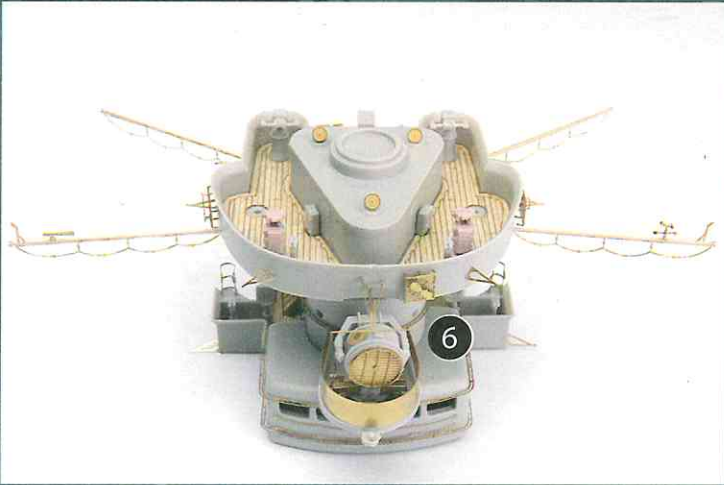

反対側にもあります。
Repeat for opposite side.
Wiederholung für gegenüberliegende Seite.
Répétition de la page précédente.
También en el lado opuesto.
另一邊照樣製作。
반대쪽도 조립합니다.

×2
2組つくります。
Make 2 sets.
2 Sätze erstellen.
Realizar dos juegos.
Ensamblar dos juegos.
同様の製作2套。
同樣的製作2套。
2번 조립합니다.

どちらかを選びます。
Optional parts.
Teils nach Wahl.
Pièces au choix.
Seleccione uno.
可以選擇使用。
선택 부품입니다.

切り取ります。
Remove.
Beschneiden.
Découper.
Corte.
切っ
잘라냅니다.

A1
01
(01)
Plastic Kit Parts No.
P.E. Parts No.
Opposed No.

Resin

MS20019-C01

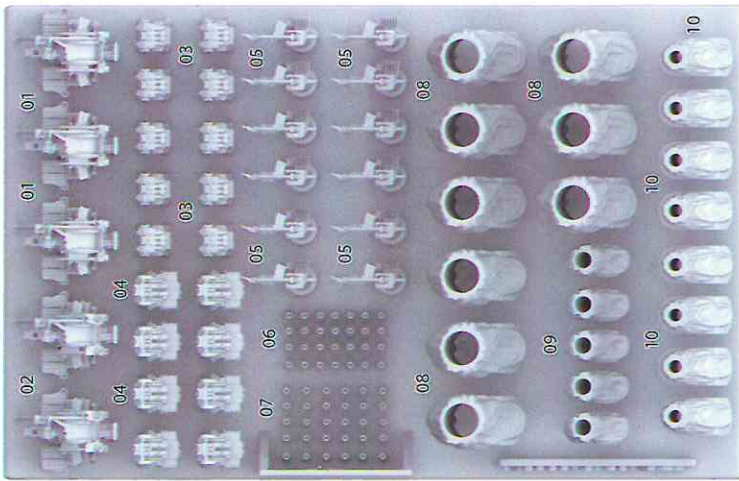

CNC

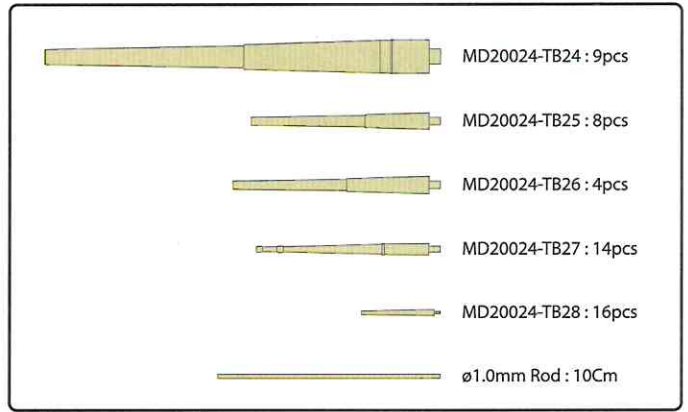

AM Armament Detail-up Set

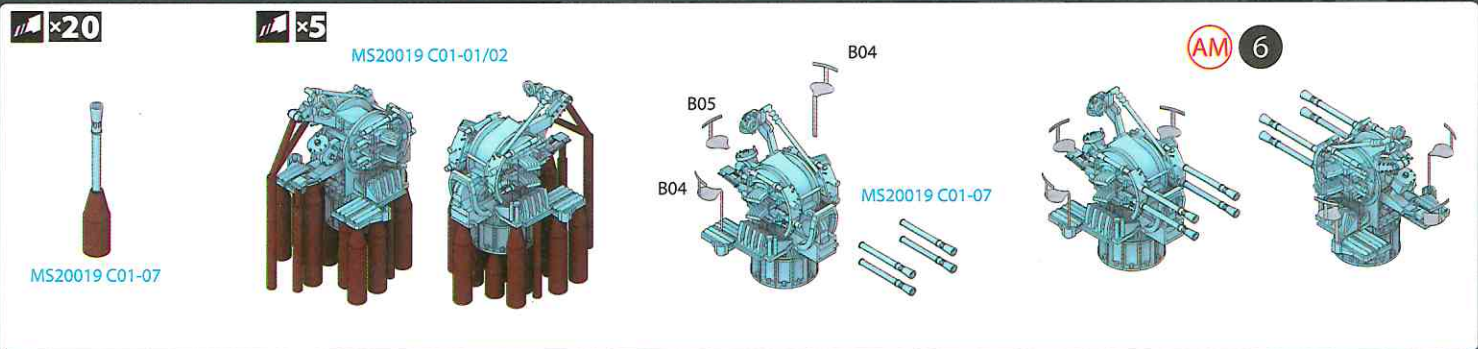
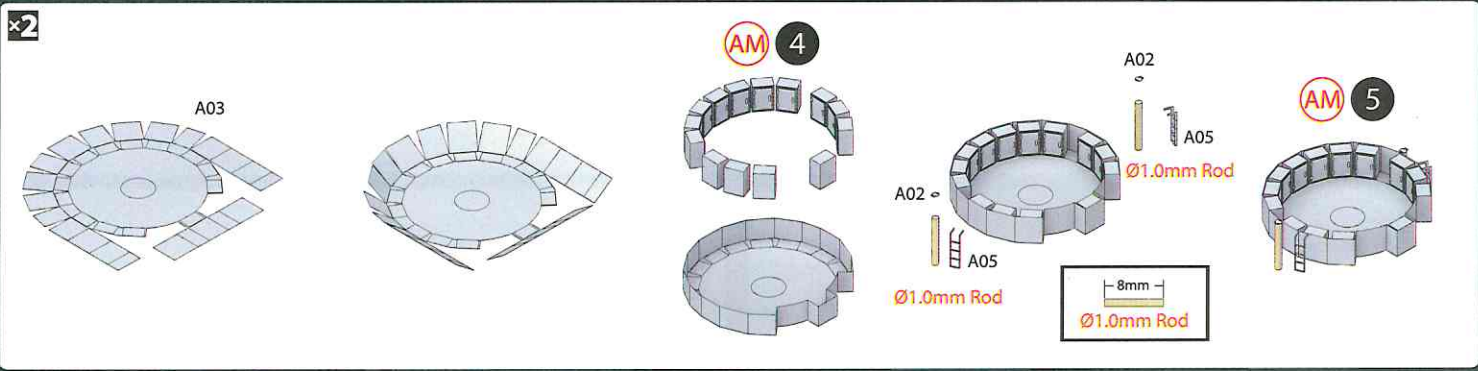
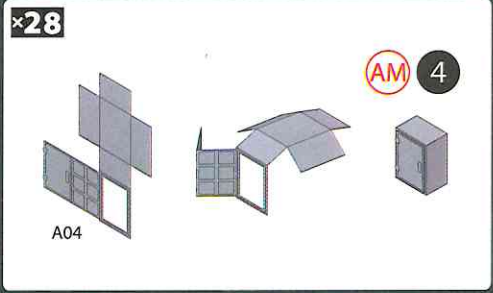
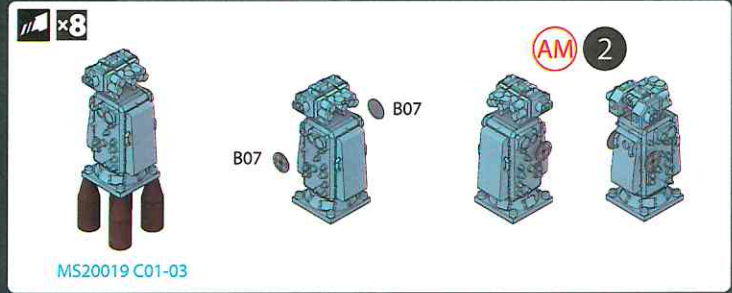
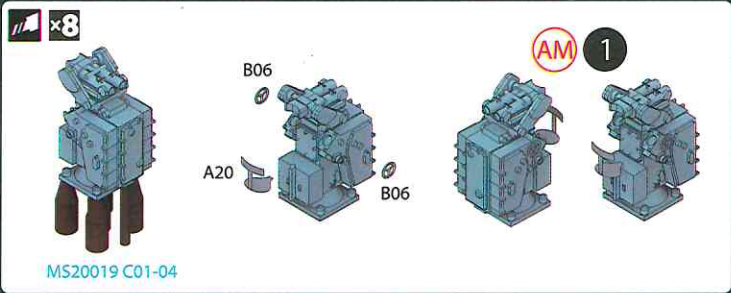

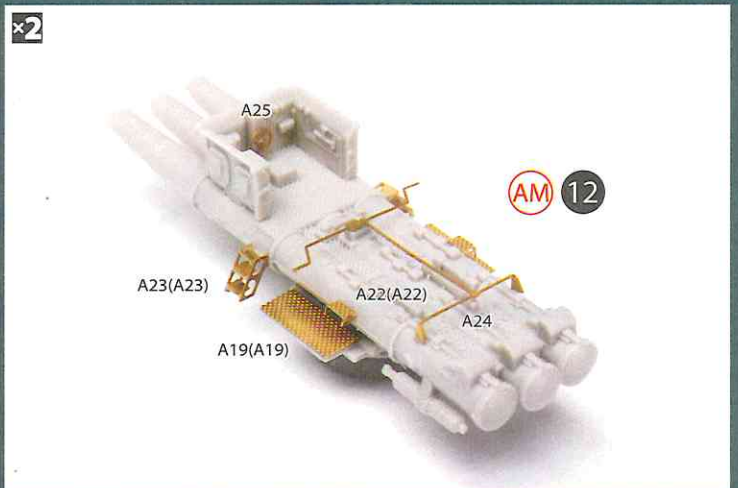
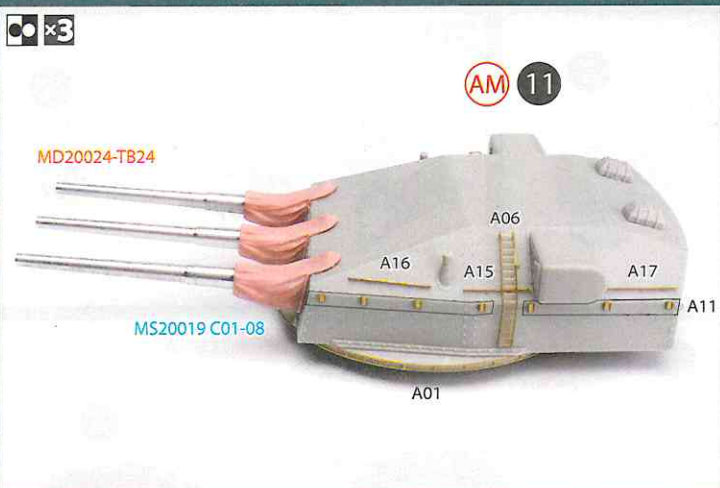
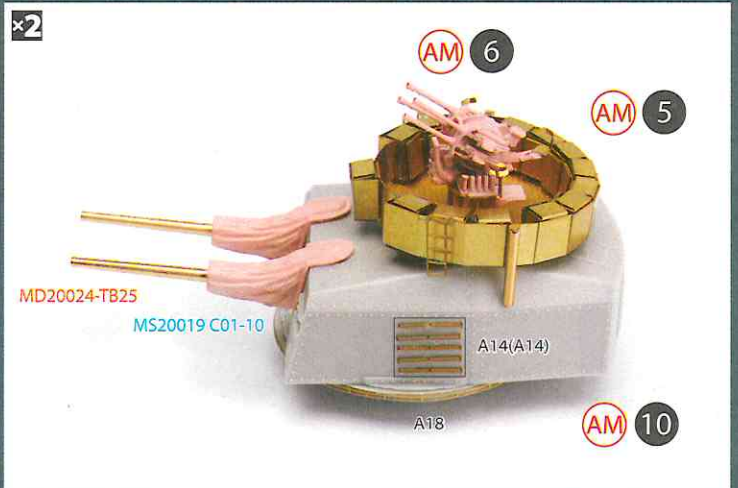
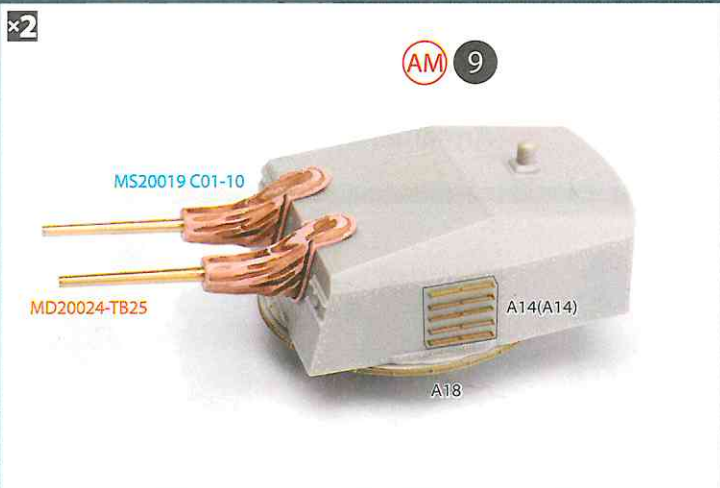
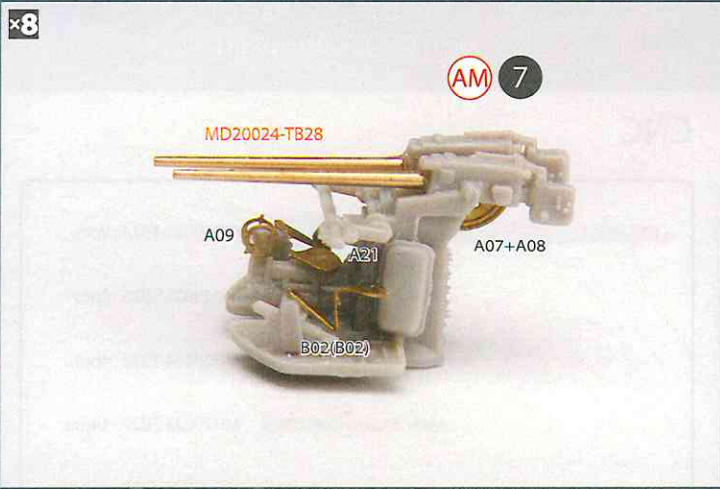

Main Mast #2

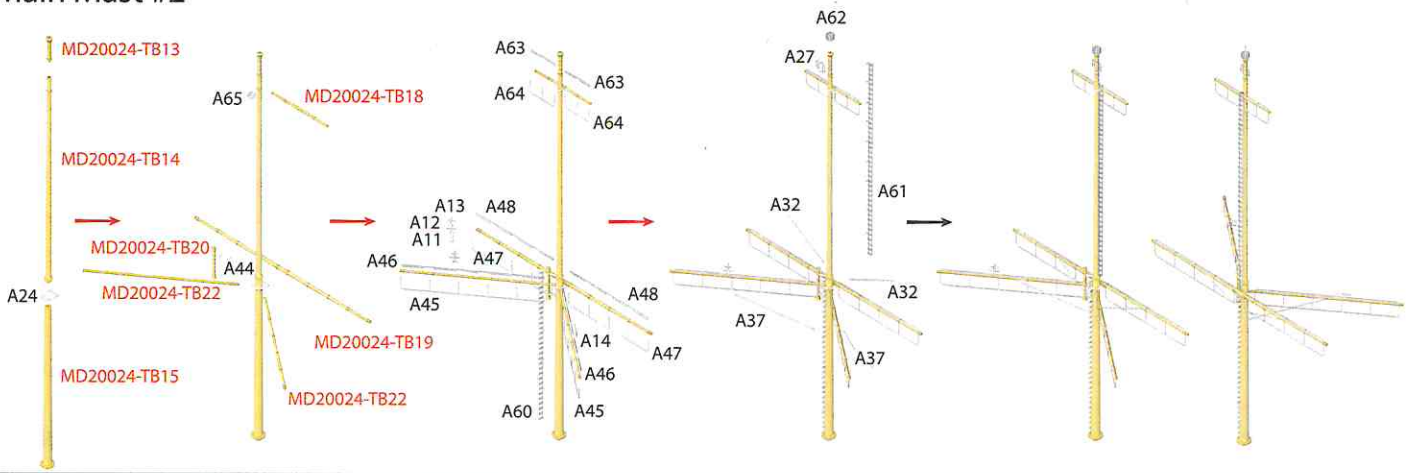

Main Mast

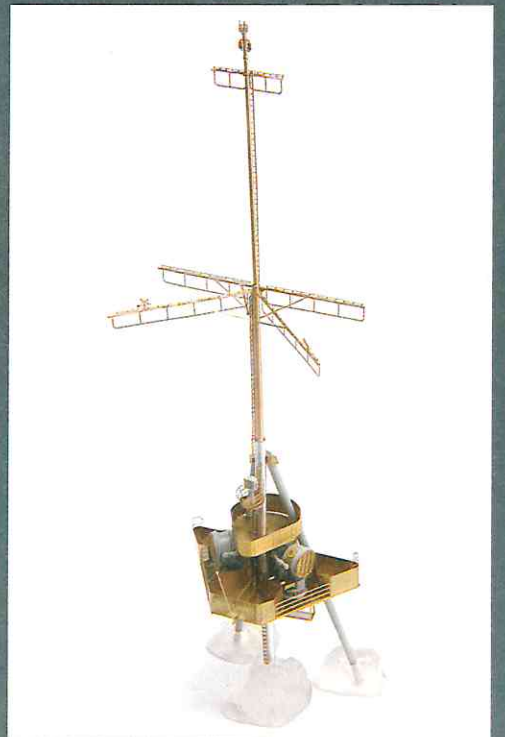
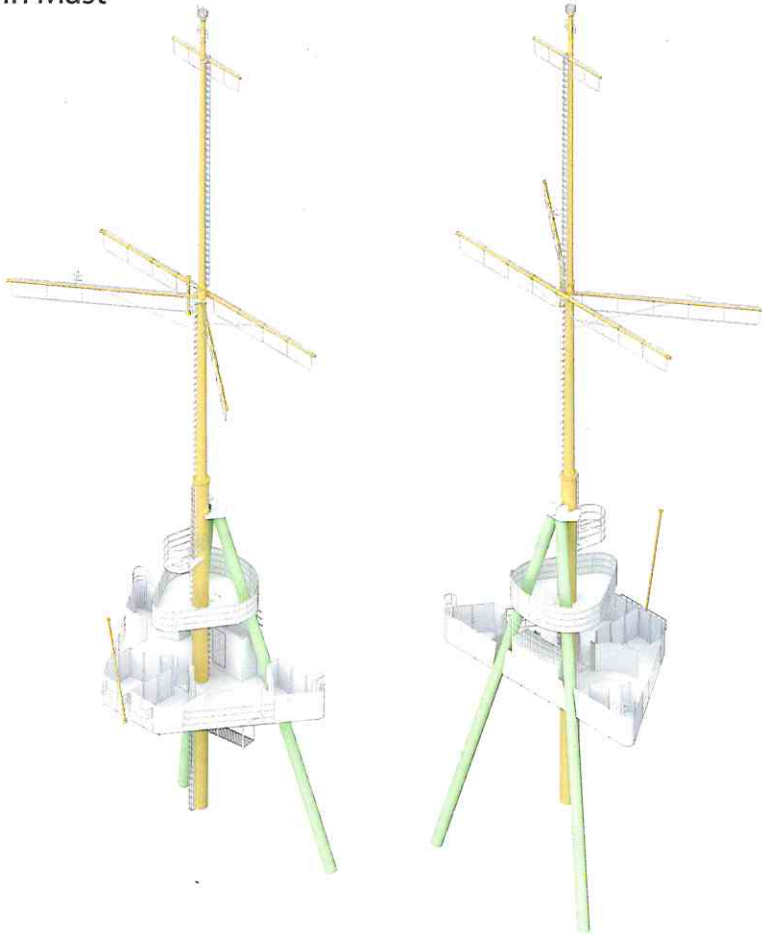

反対側にもあります。
Repeat for opposite side.
Wiederholung für gegenüberliegende Seite.
Répétition de la page précédente.
También en el lado opuesto.
另一邊照樣制作。
반대쪽도 조립합니다.

×2 2組つくります。
Make 2sets.
2 Satze erstellen.
Realizar deux juegos.
Ensamble dos juegos.
同様の製作2套。
2번 조립합니다.

どちらかを選びます。
Optional parts.
Teils nach Wahl.
Pièces au choix.
Selecione uno.
可以選擇使用。
선택 부품입니다.

切り取ります。
Remove.
Beschneiden.
Découper.
Corte.
切法
잘라냅니다.

A1 Plastic Kit Parts No.
01 P.E. Parts No.
(01) Opposed No.

MA Mast Detail-up Set

- MD20024-TB02 : 1pcs
- MD20024-TB03 : 1pcs
- MD20024-TB04 : 1pcs
- MD20024-TB05 : 1pcs
- MD20024-TB06 : 1pcs
- MD20024-TB07 : 1pcs
- MD20024-TB08 : 1pcs
- MD20024-TB13 : 1pcs
- MD20024-TB14 : 1pcs
- MD20024-TB15 : 1pcs
- MD20024-TB16 : 1pcs
- MD20024-TB17 : 1pcs
- MD20024-TB18 : 1pcs
- MD20024-TB19 : 1pcs
- MD20024-TB20 : 1pcs
- MD20024-TB21 : 1pcs
- MD20024-TB22 : 2pcs

Fore Mast

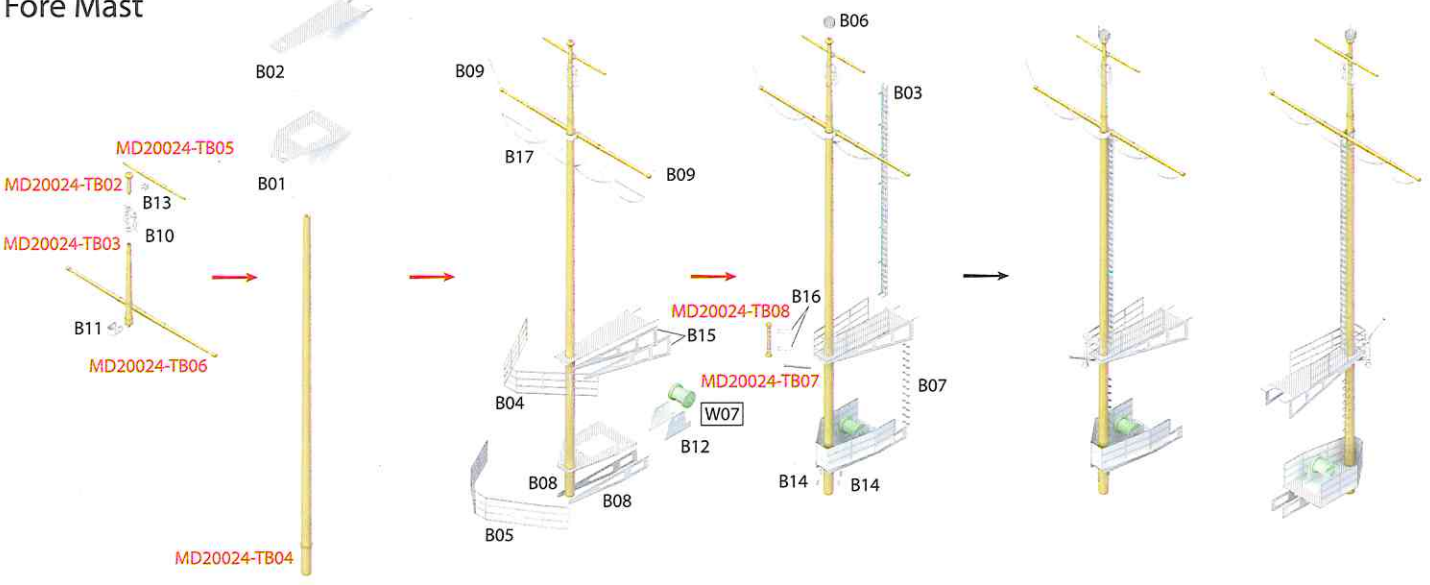

Main Mast #1

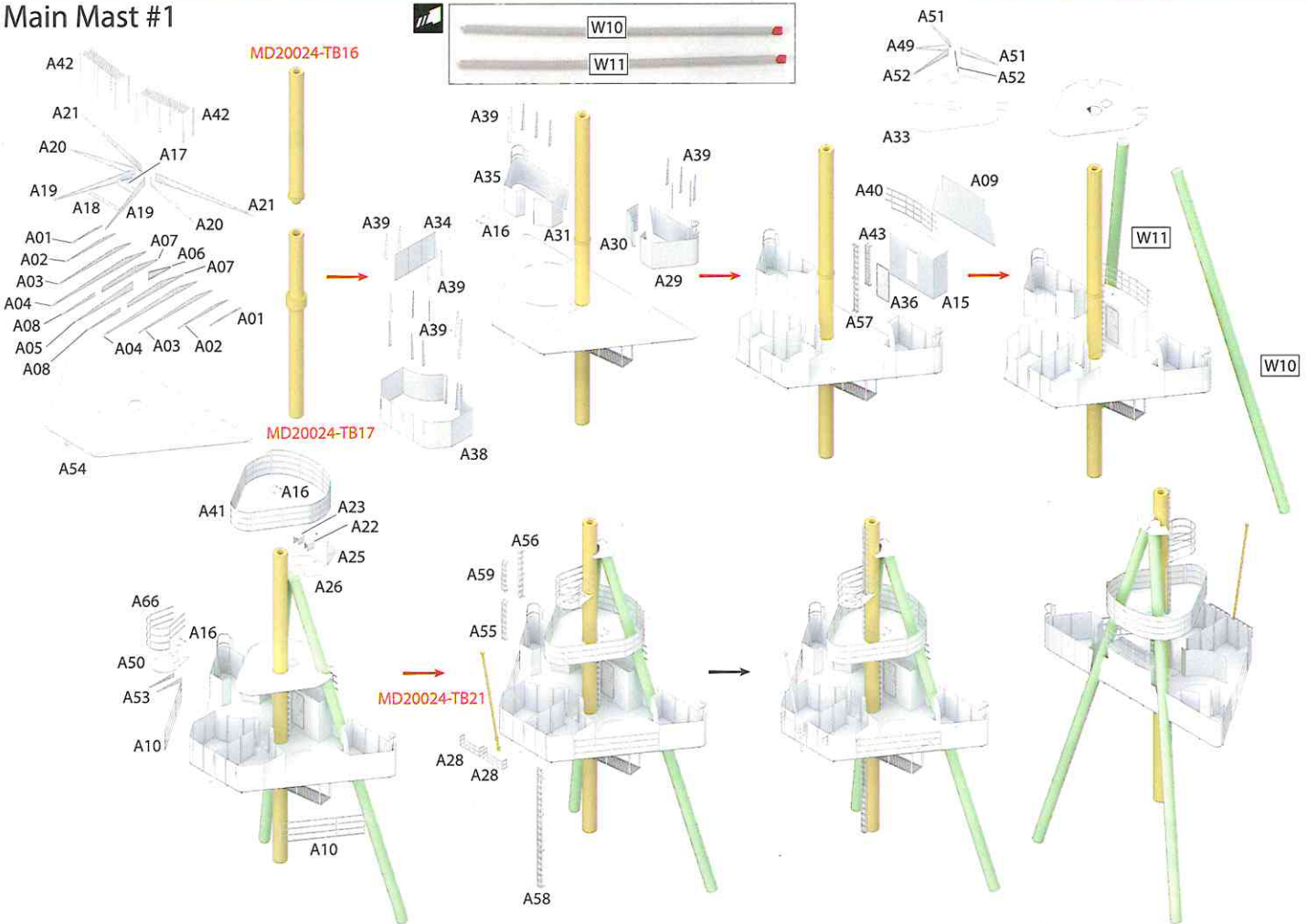

反対側にもあります。
Reverse for opposite side.
Invertieren für gegenüberliegende Seite.
Invertirar de la parte opuesta.
Invertir en el otro extremo.
逆側にもあります。
반대쪽도 포함됩니다.

×2
2個つくります。
Make 2 each.
2 Sets erstellen.
Realizar dos juegos.
Ensamblar dos juegos.
Assemble in a pair.
2인 포함됩니다.
2번 포함됩니다.

オプションパーツです。
Optional parts.
Für nach Wahl.
Pieces au choix.
Selecciona uno.
اختيارية.
선택 가능합니다.
선택 가능합니다.

切り取ります。
Remove.
Beschneiden.
Découper.
Corta.
잘라냅니다.
잘라냅니다.

A1 Plastic Kit Parts No.
01 P.E. Parts No.
(01) Opposed No.

RA Radar Detail-up Set

- F** : Front View
- B** : Back View
- B** : for Beginner
- E** : for Expert

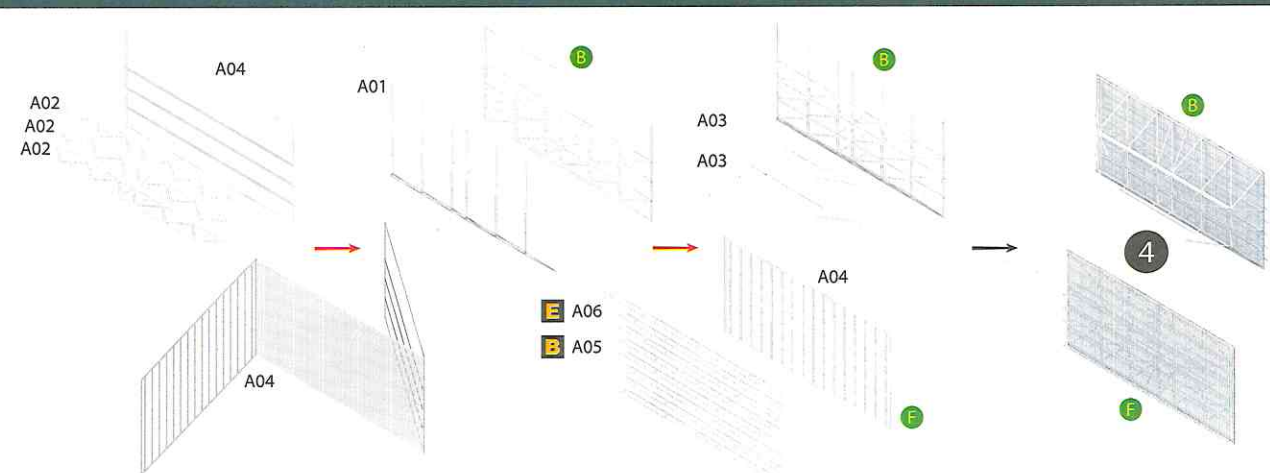
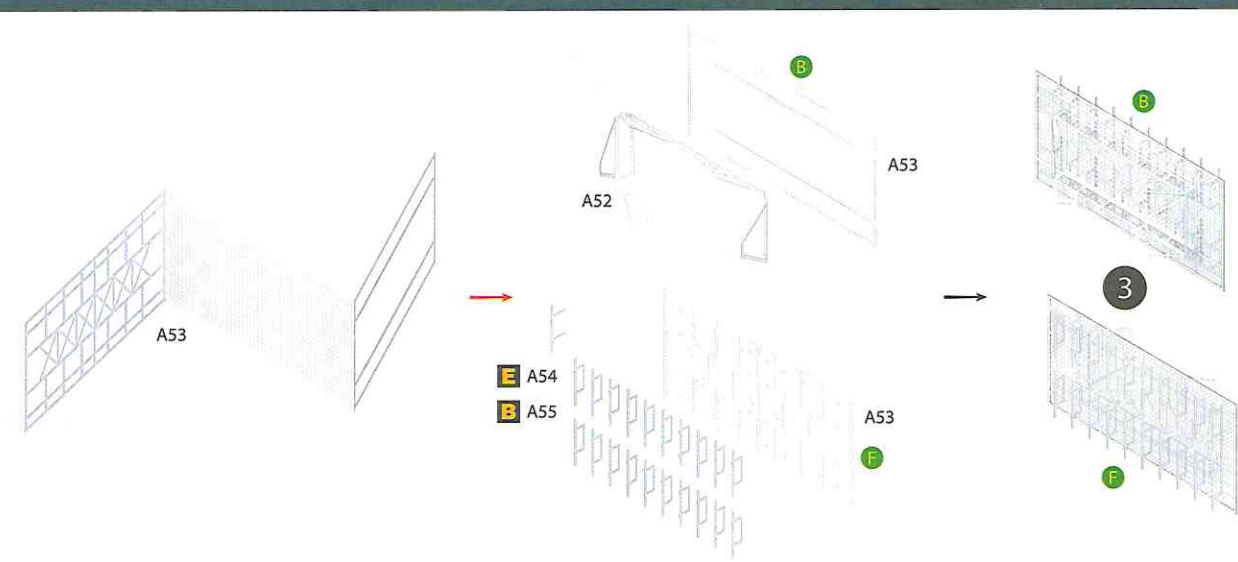
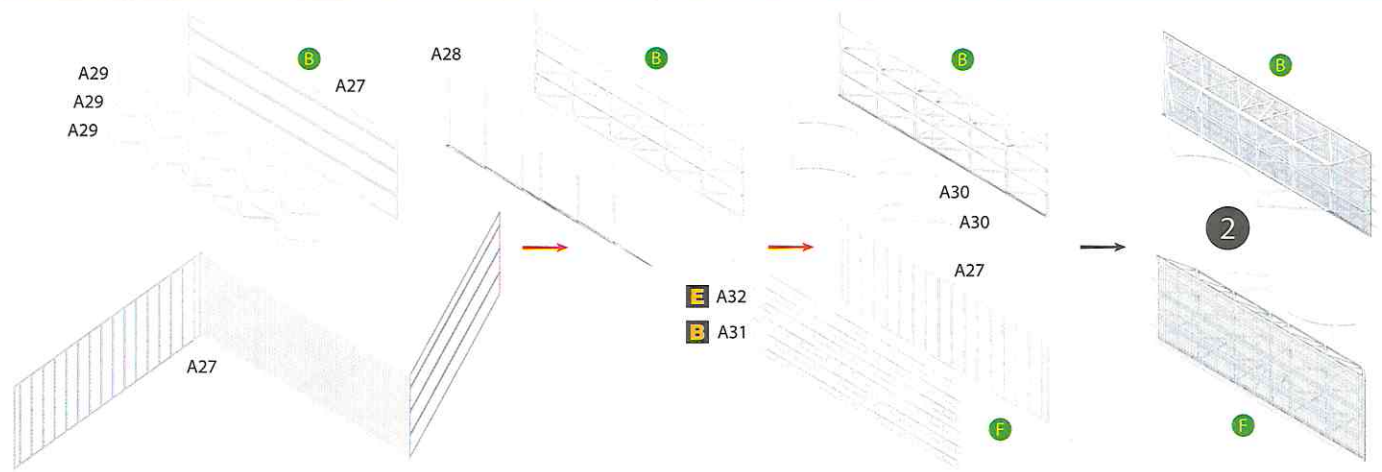
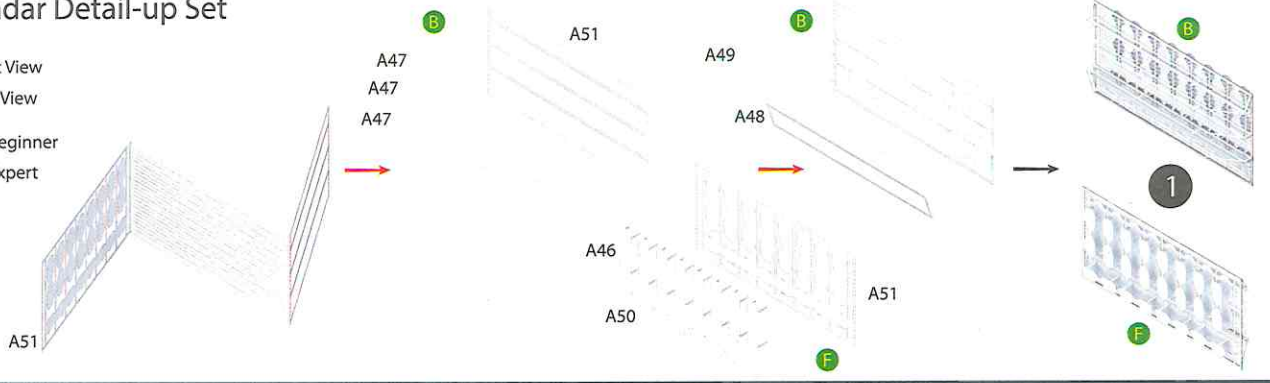

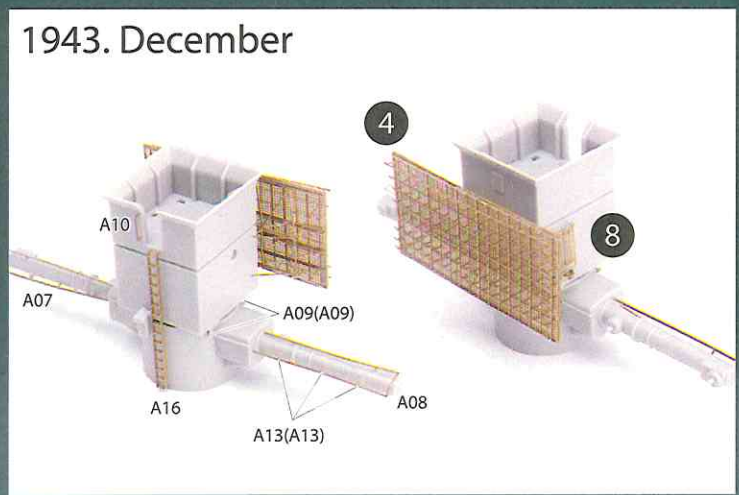
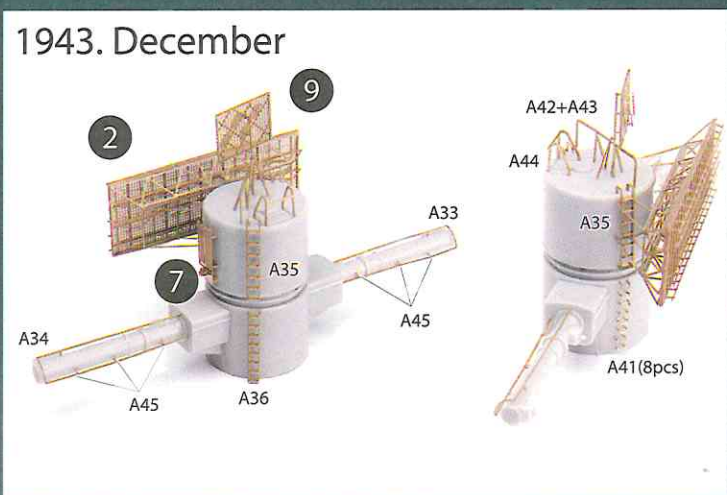
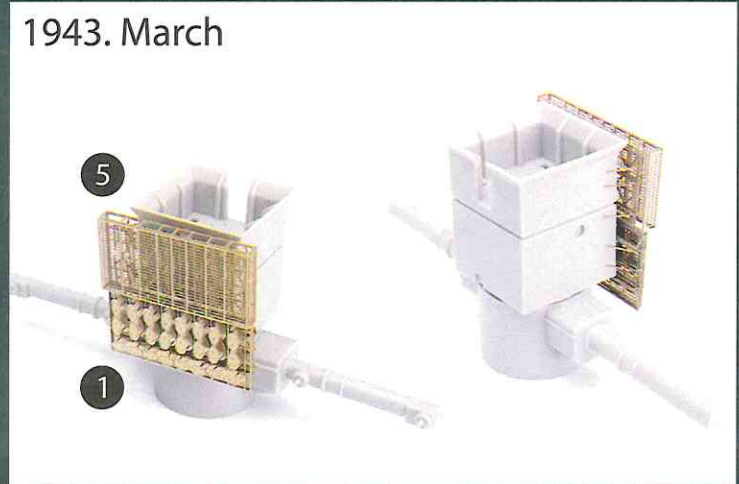
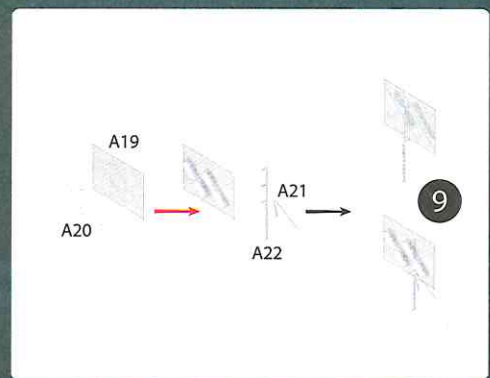
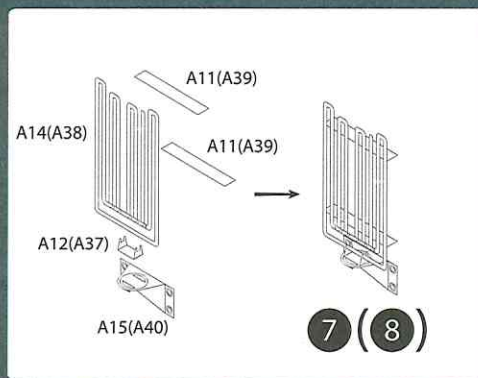
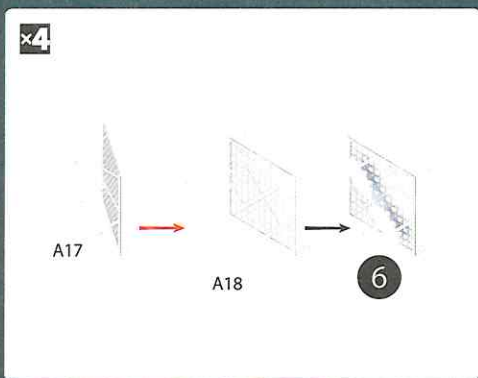
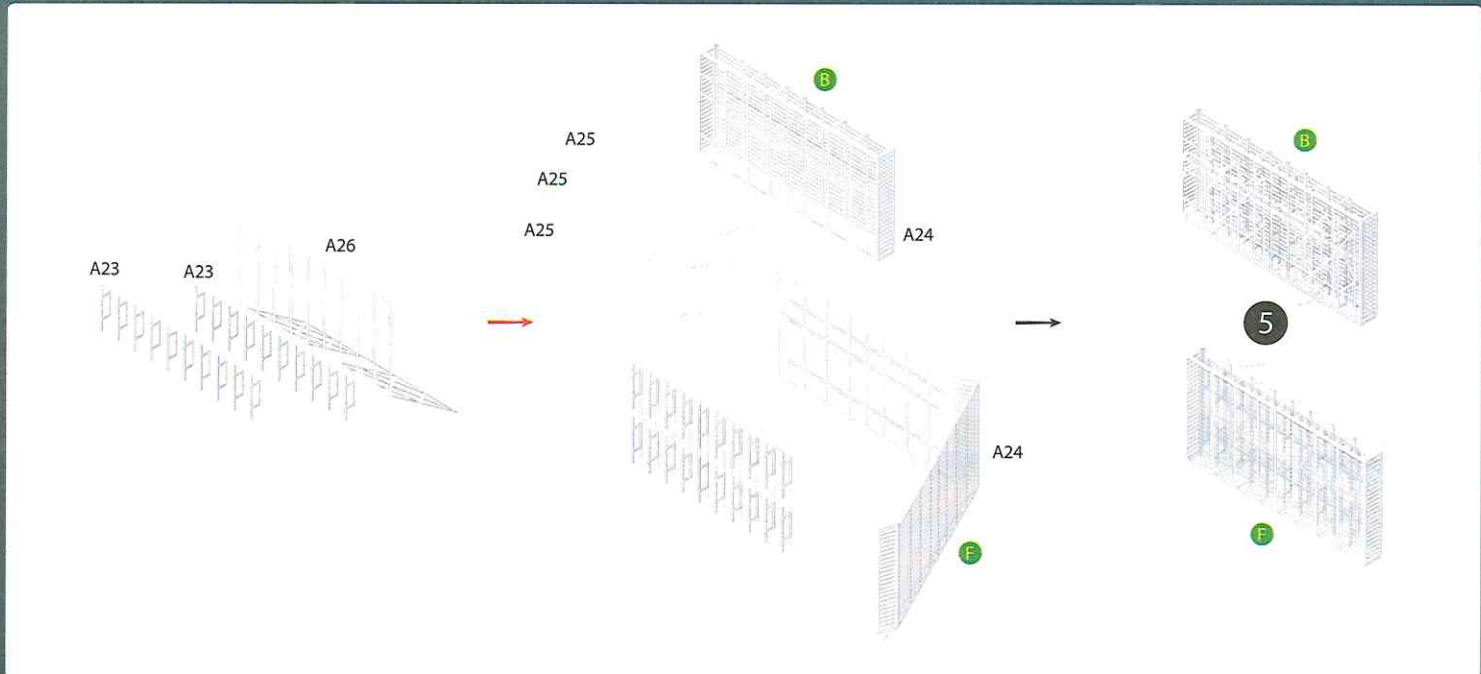



反対側にもあります。
Repeat for opposite side.
Wiederholung für gegenüberliegende Seite.
Répétition de la page précédente.
También en el lado opuesto.
另一邊照樣製作。
반대쪽도 조립합니다.



2組つくります。
Make 2 sets.
2 Sätze erstellen.
Realizar dos juegos.
Répétition de la page précédente.
También en el lado opuesto.
另一邊照樣製作。
반대쪽도 조립합니다.



どちらかを選びます。
Optional parts.
Teile nach Wahl.
Pièces au choix.
Seleccione uno.
可以選擇使用。
선택 부품입니다.



切り取ります。
Remove.
Beschneiden.
Découper.
Corte.
切去。
잘라냅니다.

A1 Plastic Kit Parts No.
01 P.E. Parts No.
(01) Opposed No.

Resin

MD20025-C01

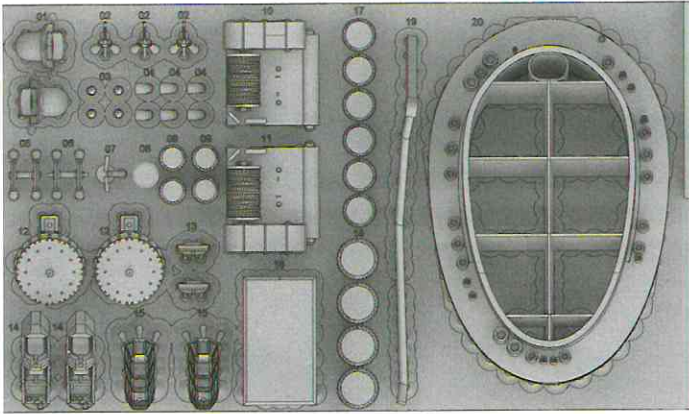

CNC

- MD20024-TB01 : 4pcs
- MD20024-TB09 : 2pcs
- MD20024-TB10 : 2pcs
- MD20024-TB12 : 2pcs
- MD20024-TB30 : 1pcs
- MD20024-TB31 : 4pcs
- MD20024-TB32 : 4pcs
- MD20024-TB33 : 2pcs
- MM022 : 1pcs
- MS20003-TB01 : 4pcs
- ø0.5mm Rod : 5Cm

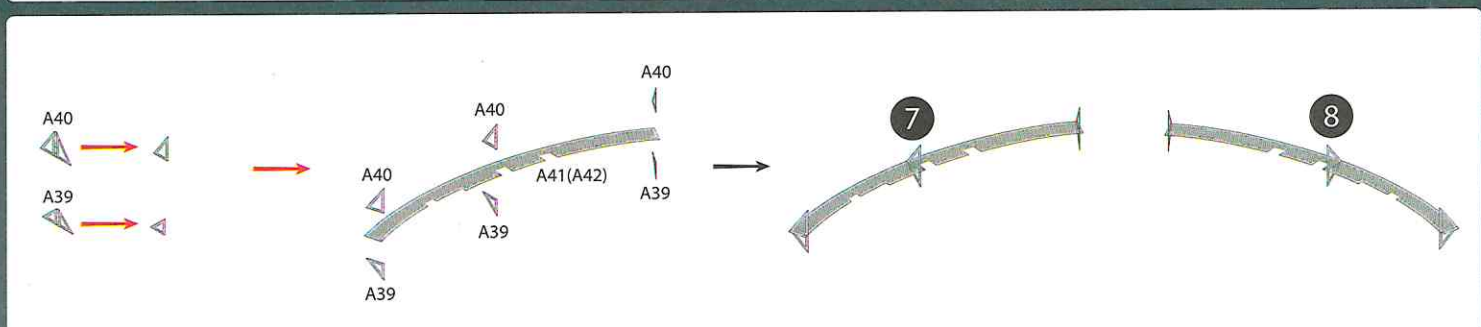
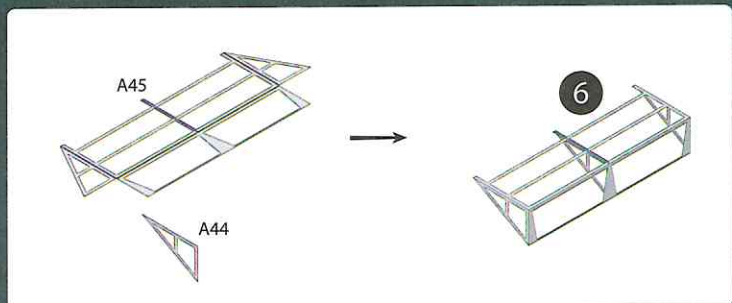
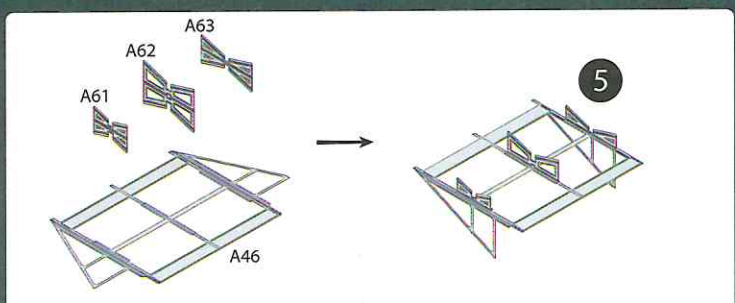
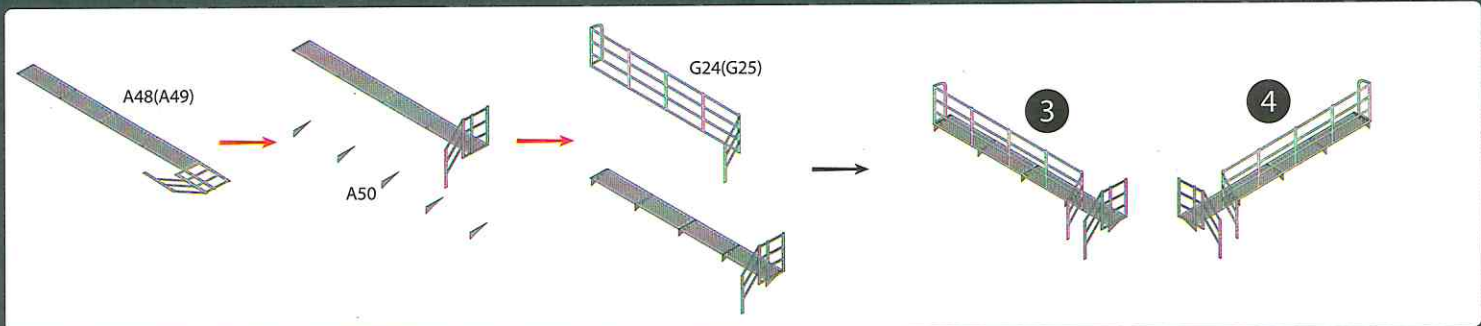
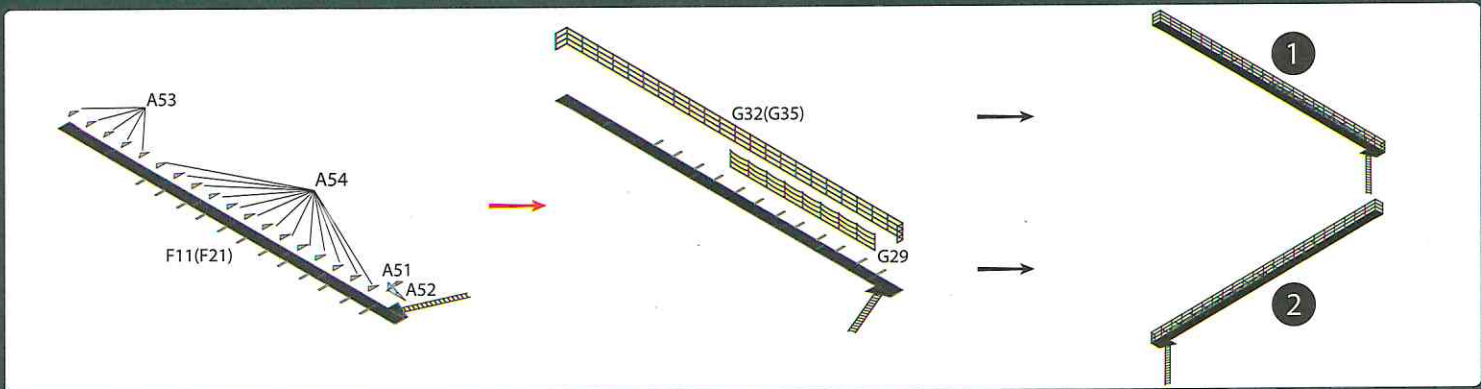

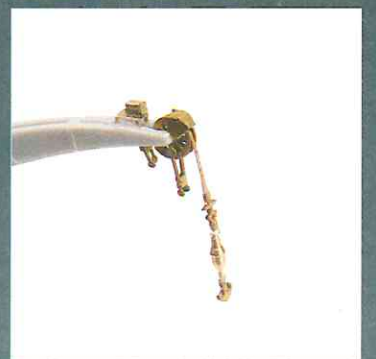
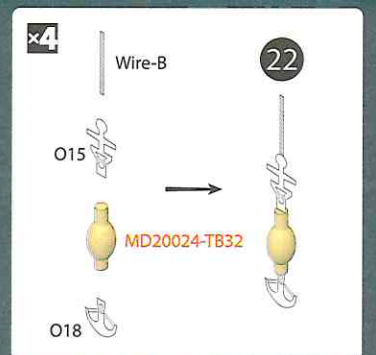
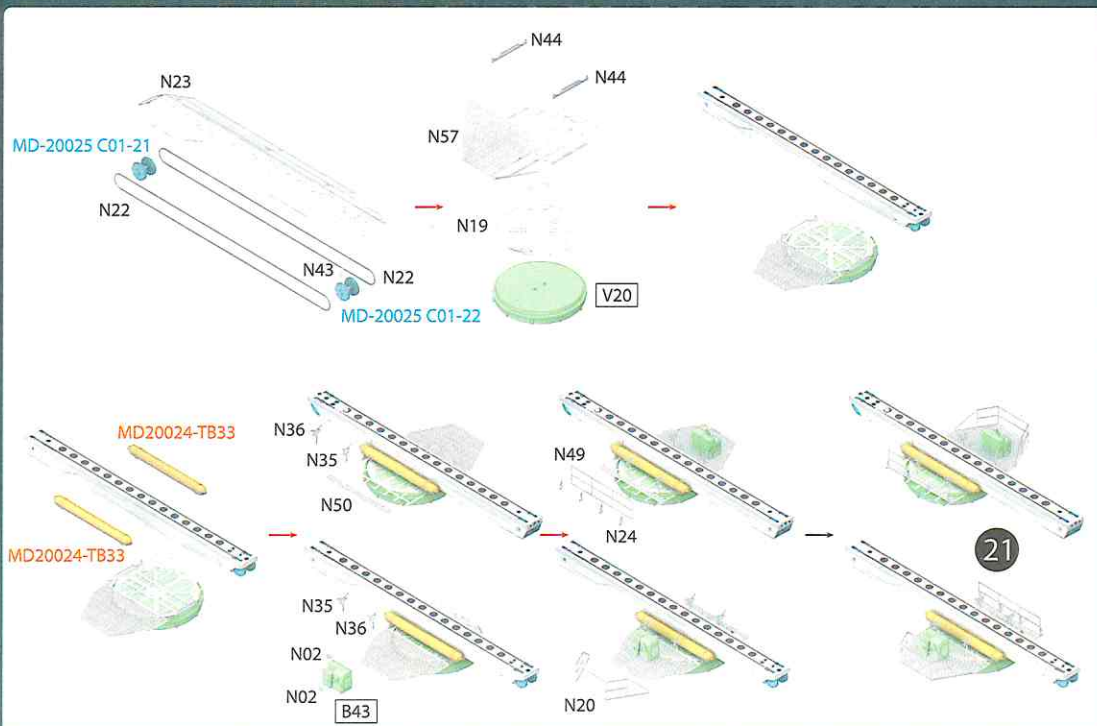
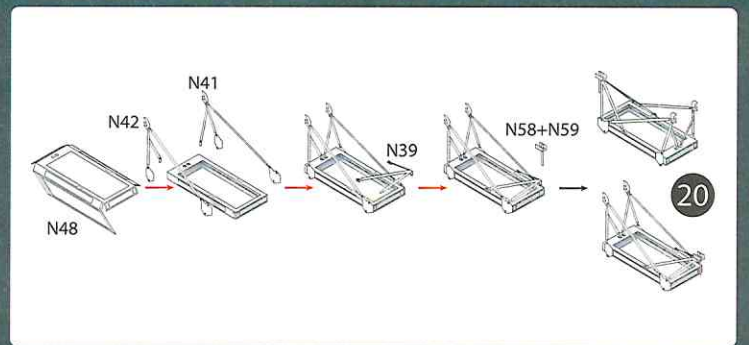
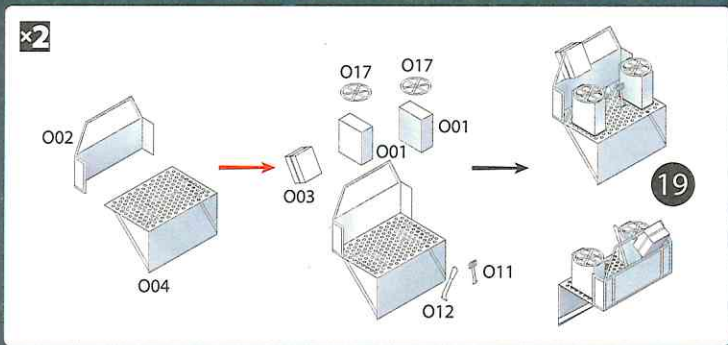
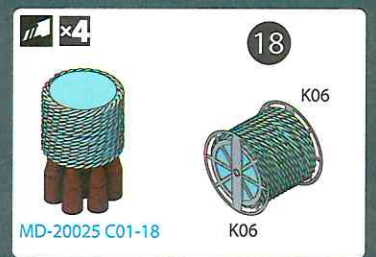
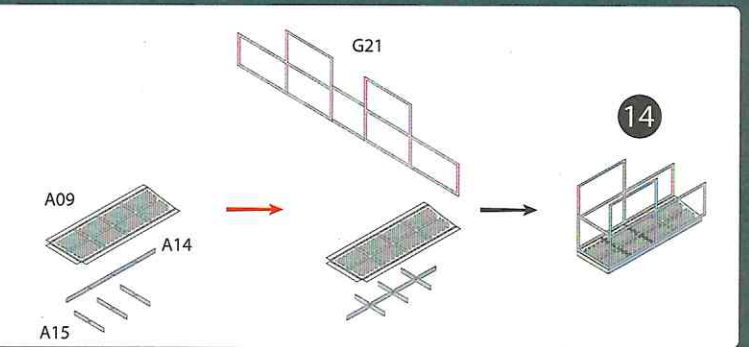
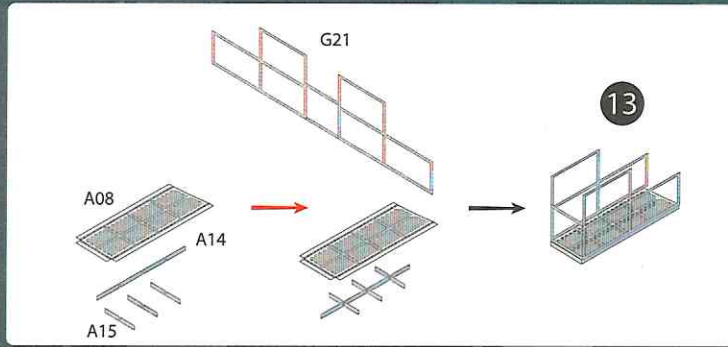
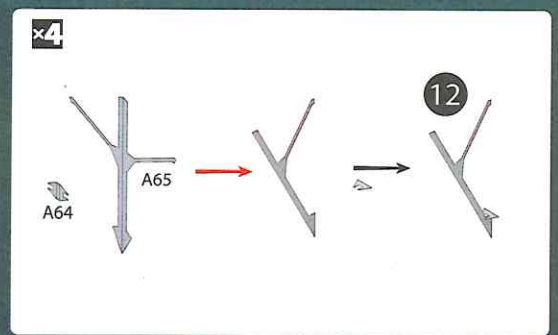
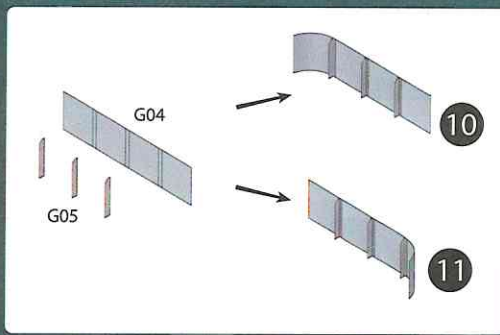
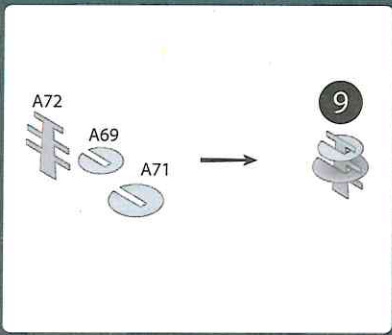

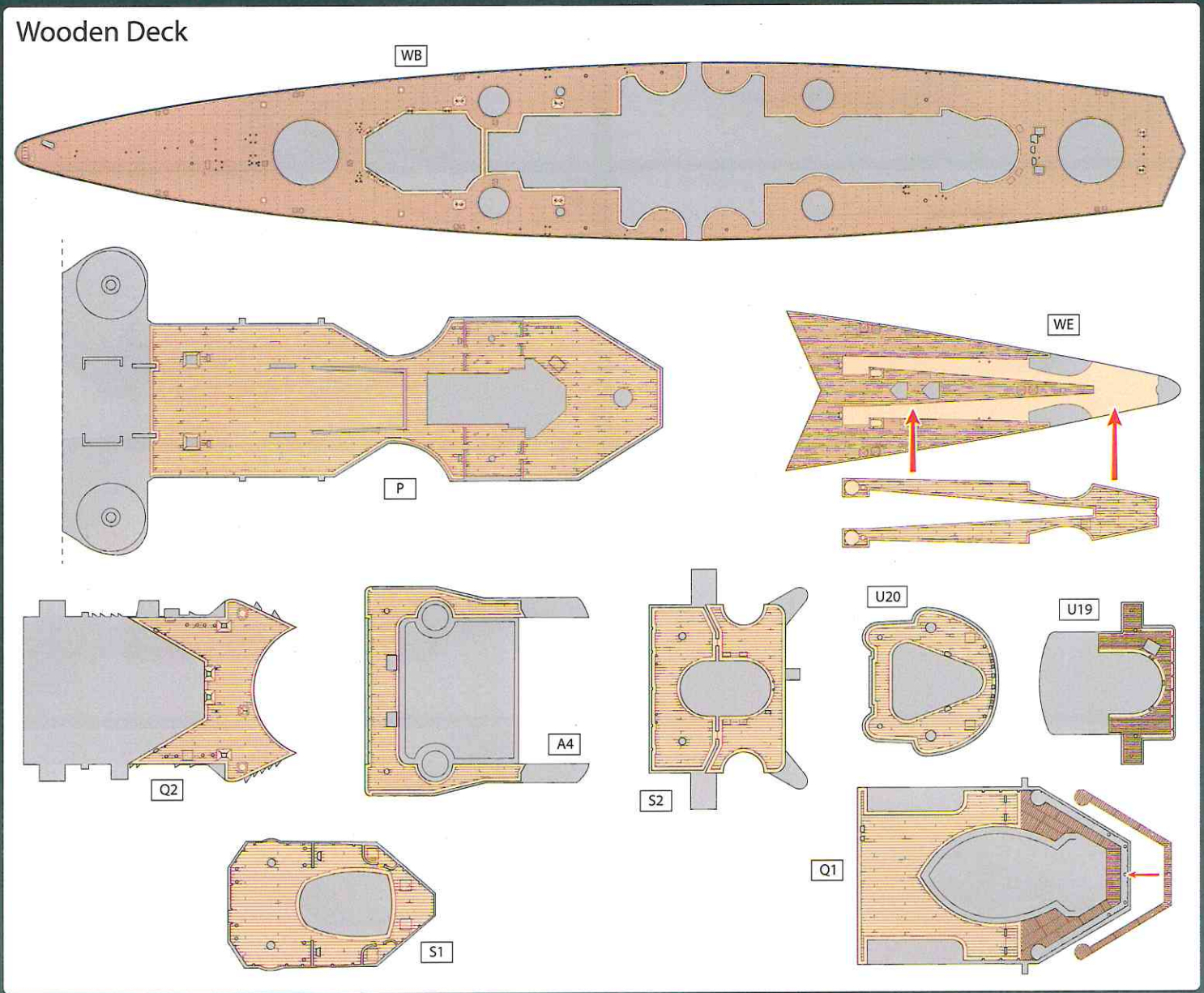
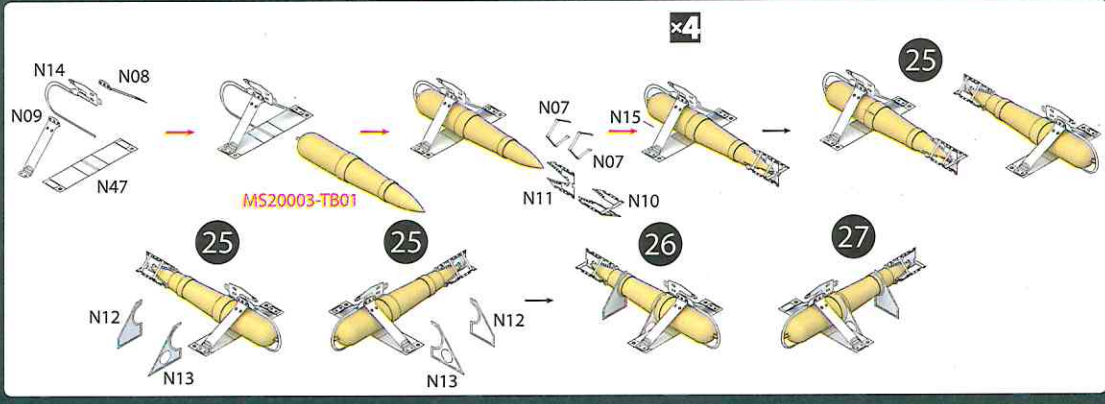
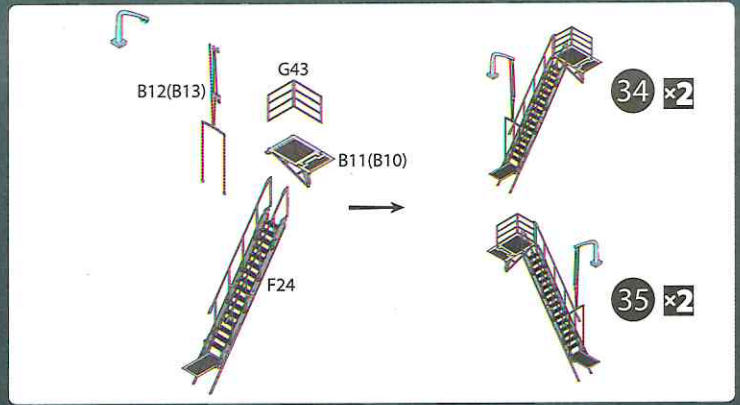
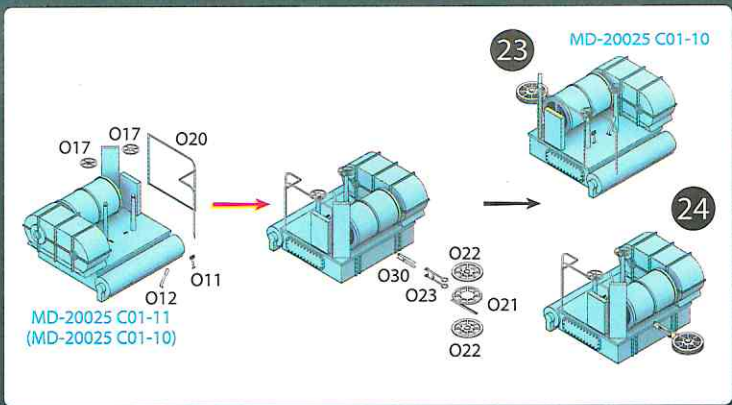

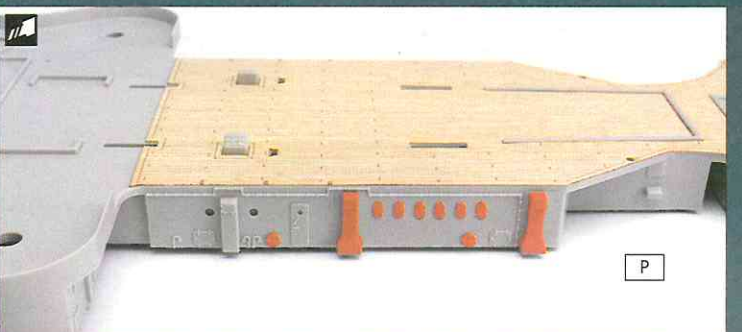
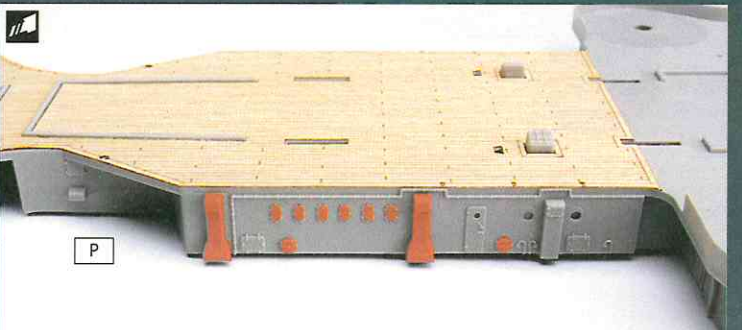
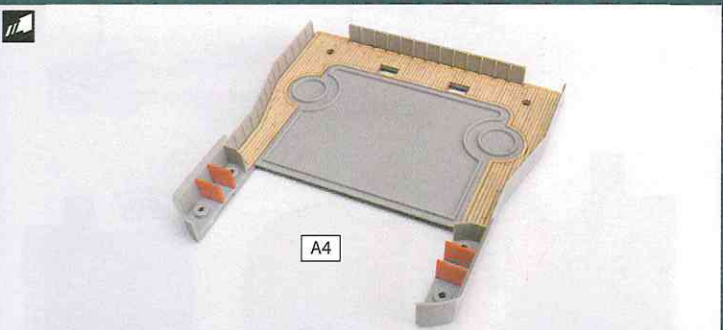
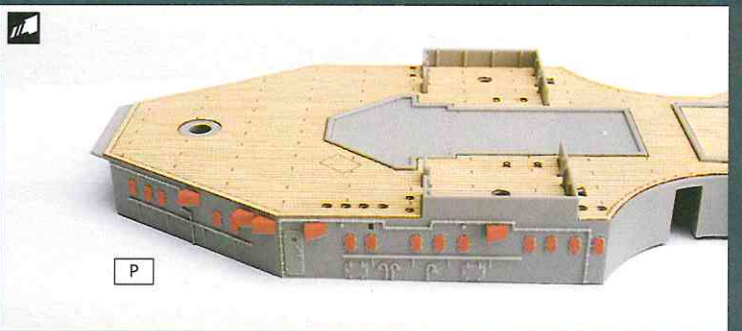
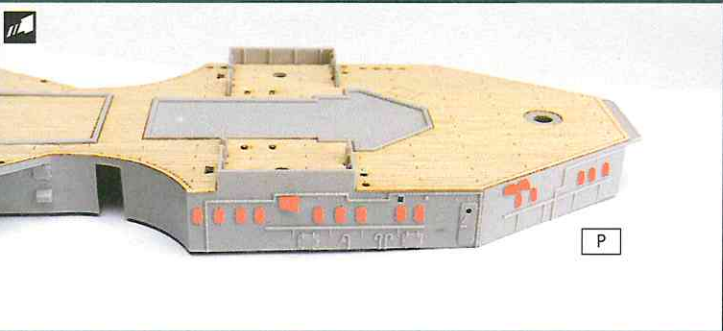
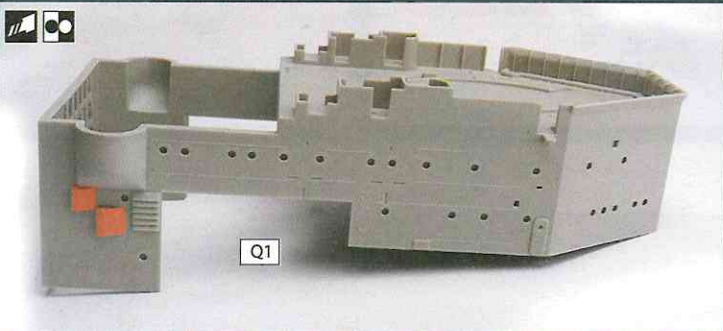
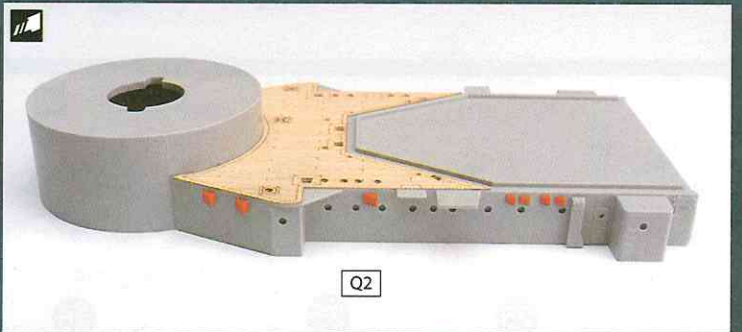
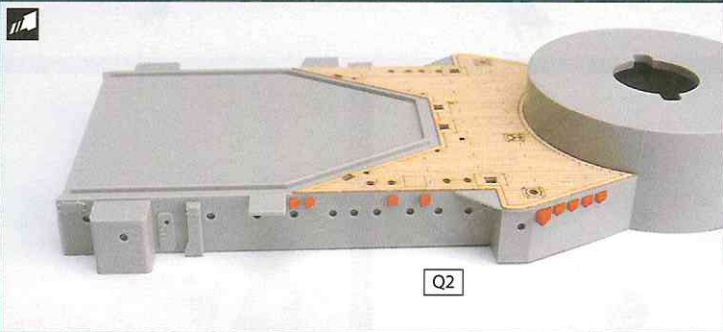
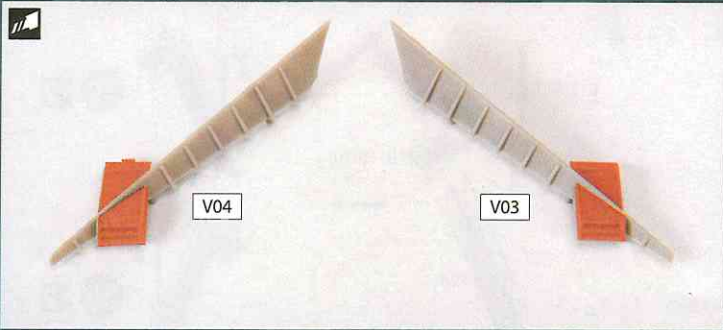

28

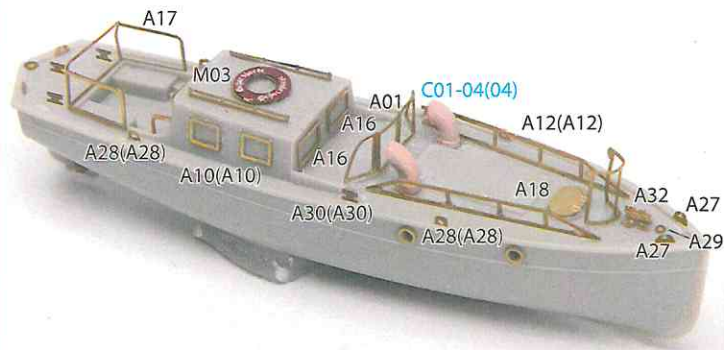

ADMIRALSBOOT

28

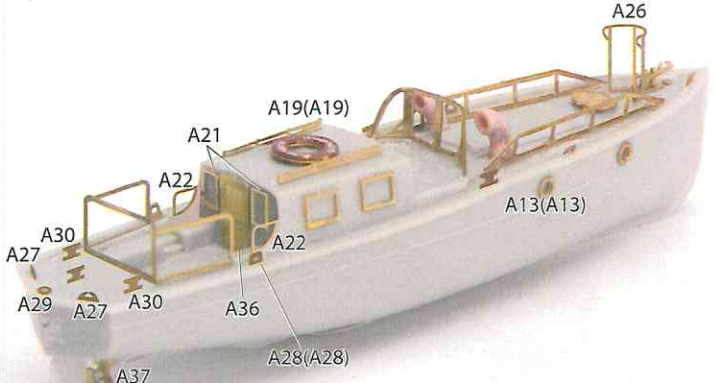

ADMIRALSBOOT

29

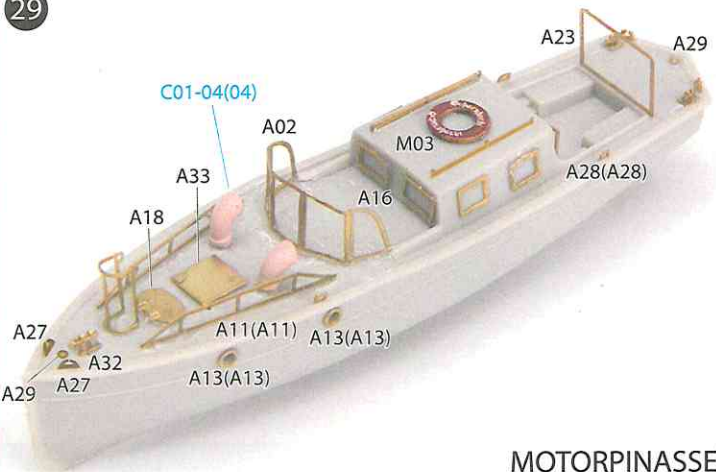

MOTORPINASSE

29

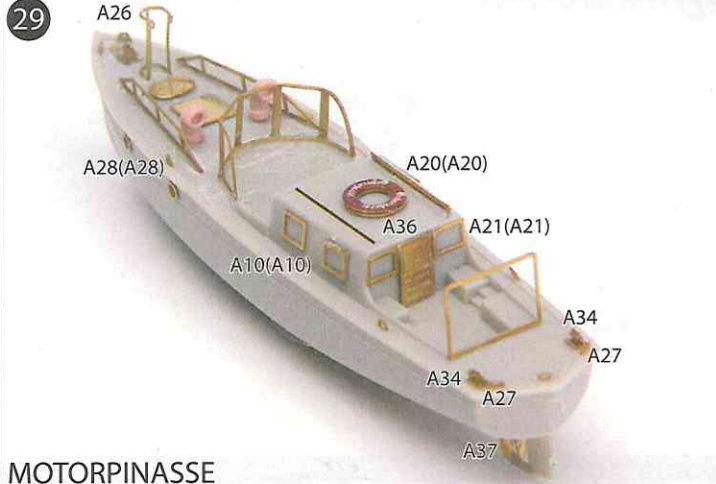

MOTORPINASSE

×3 30

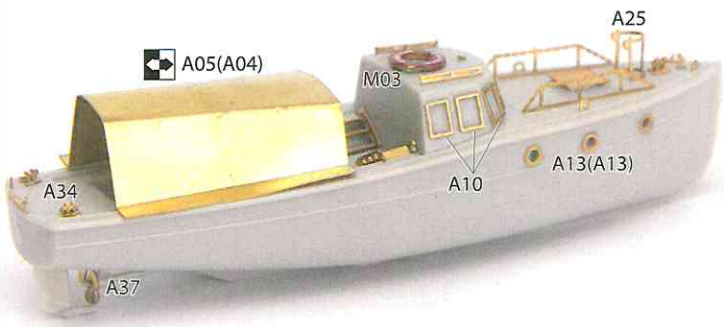

VERKEHRSBOOT

×3 30

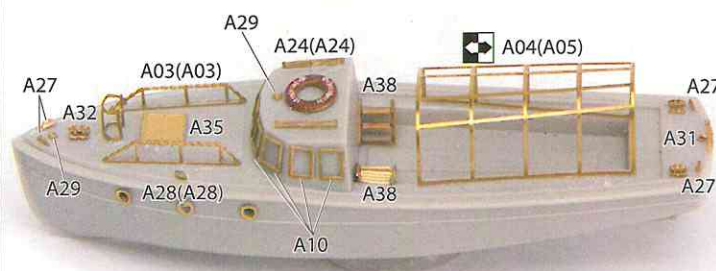

VERKEHRSBOOT

×5 31

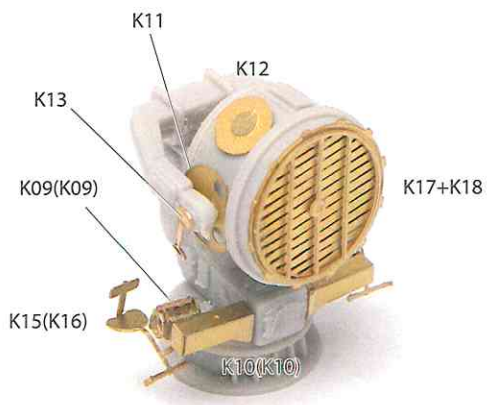

×4 32



33

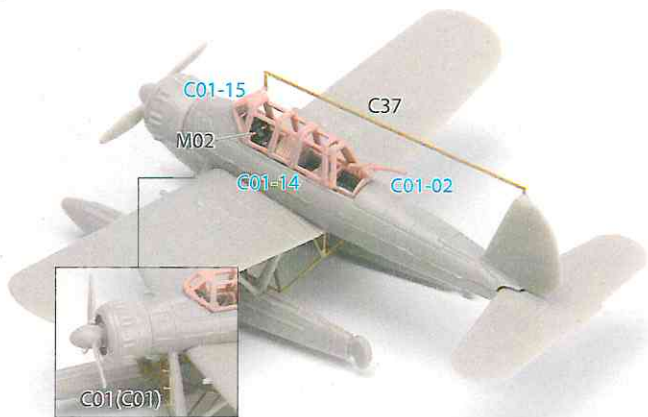

33

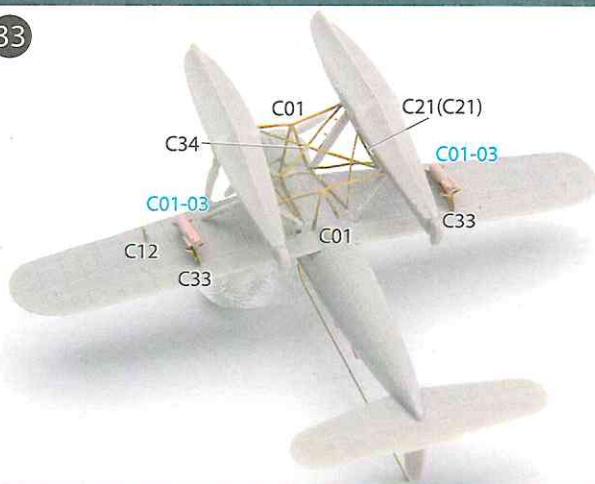

33 WING FOLDED

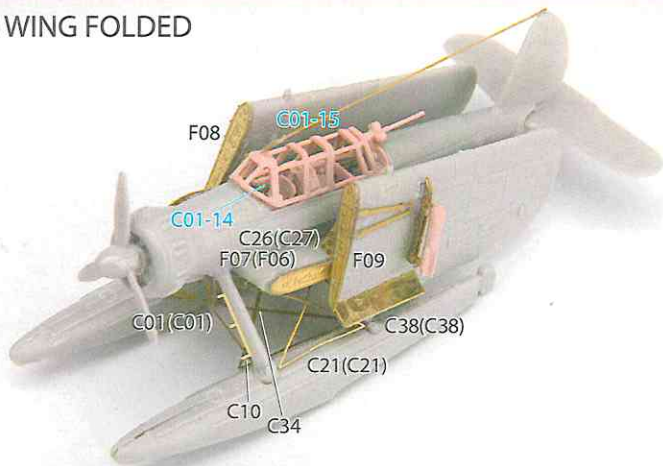

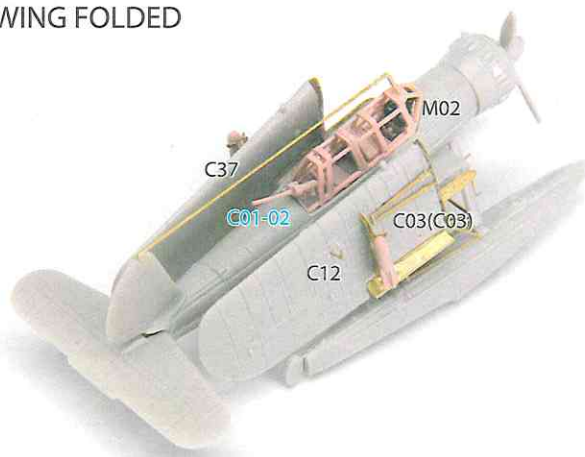

33 WING FOLDED

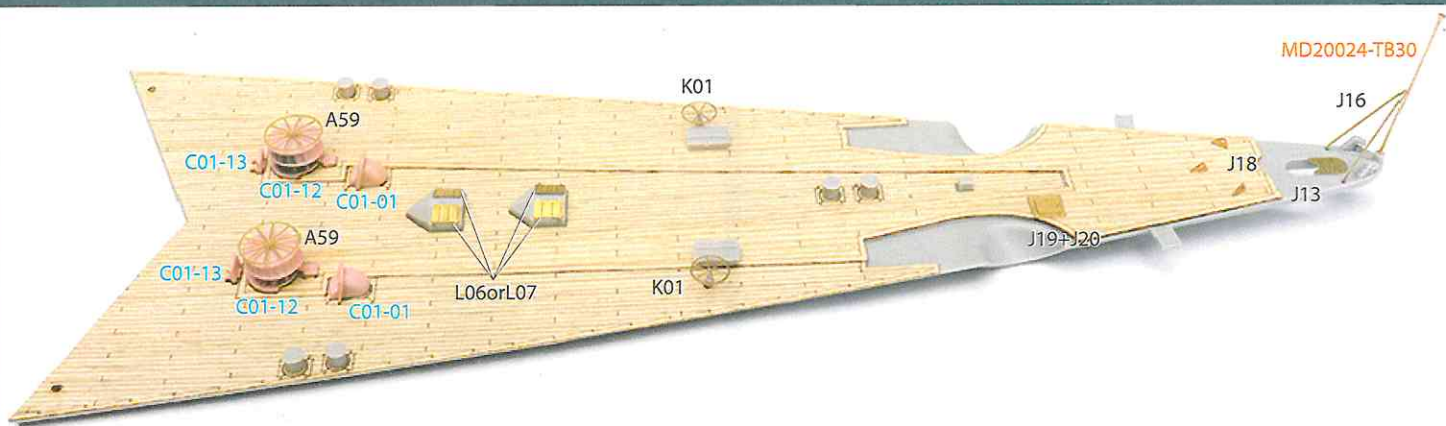
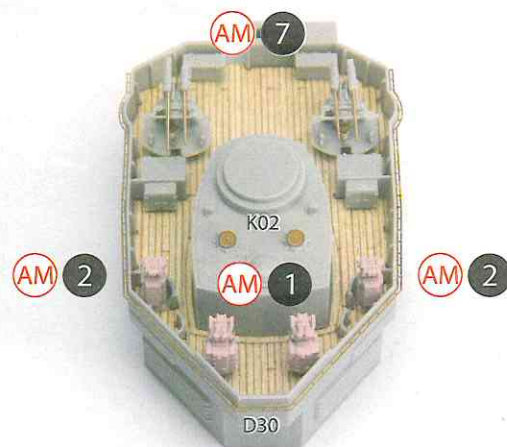
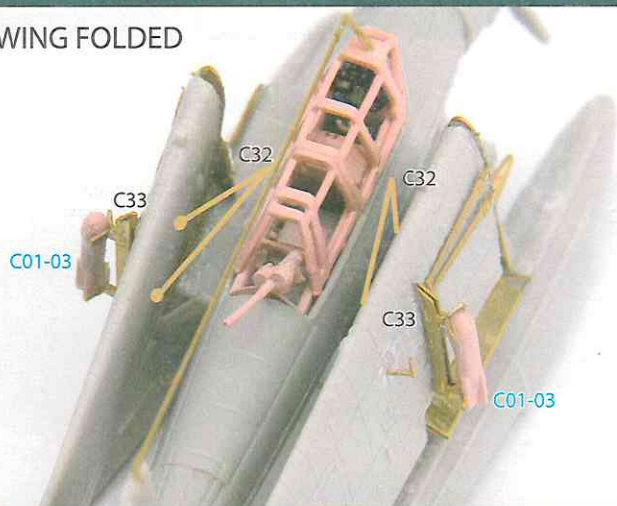

33 WING FOLDED

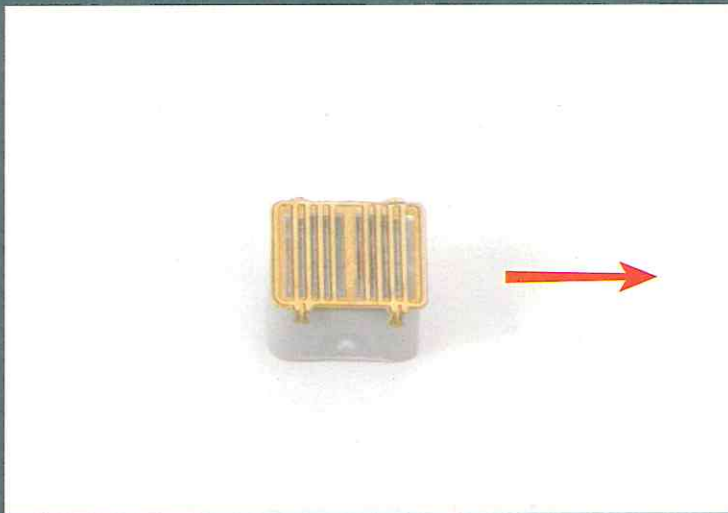



number	code	open		close
×10	X21	L01		L03
×2	X19	L08		L09
×4	E15	L05		L04

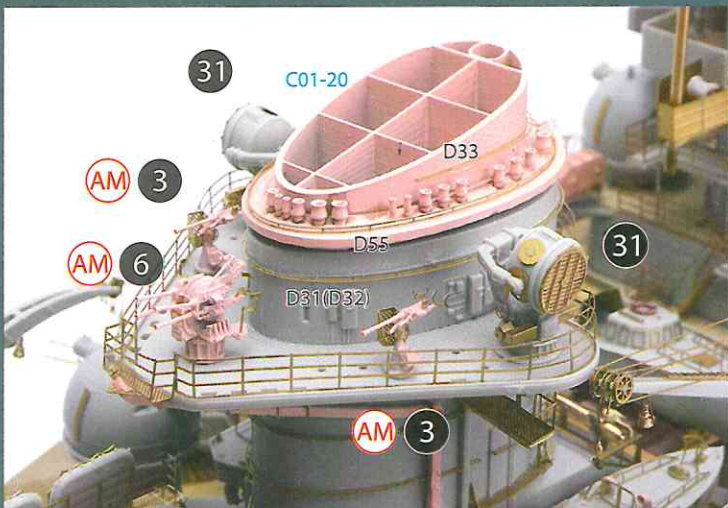
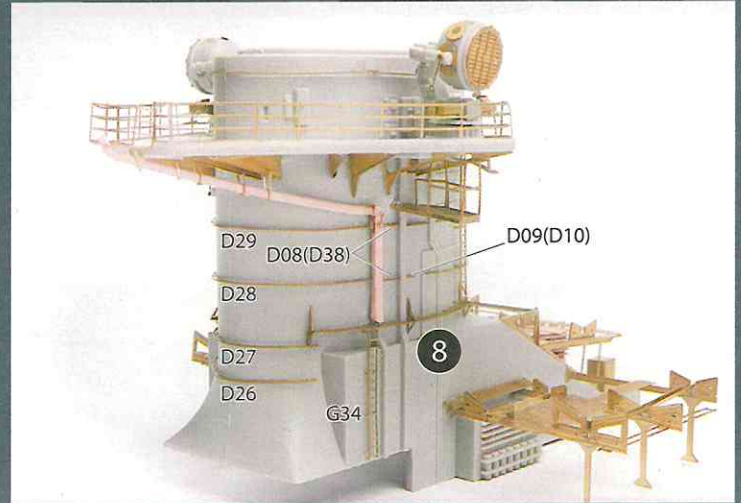
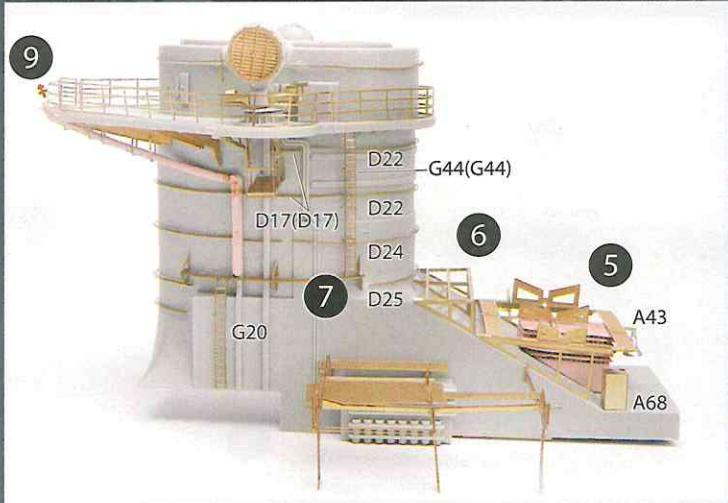
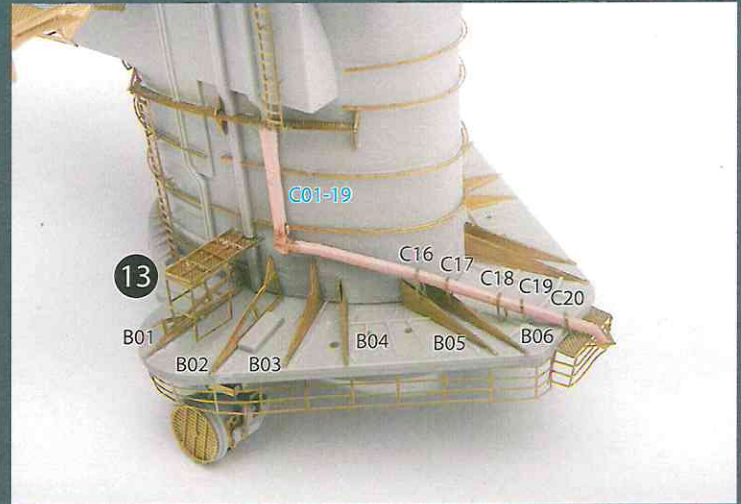
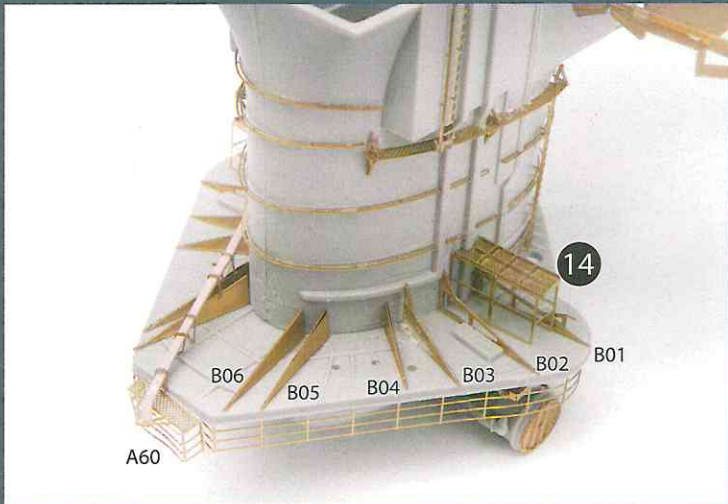

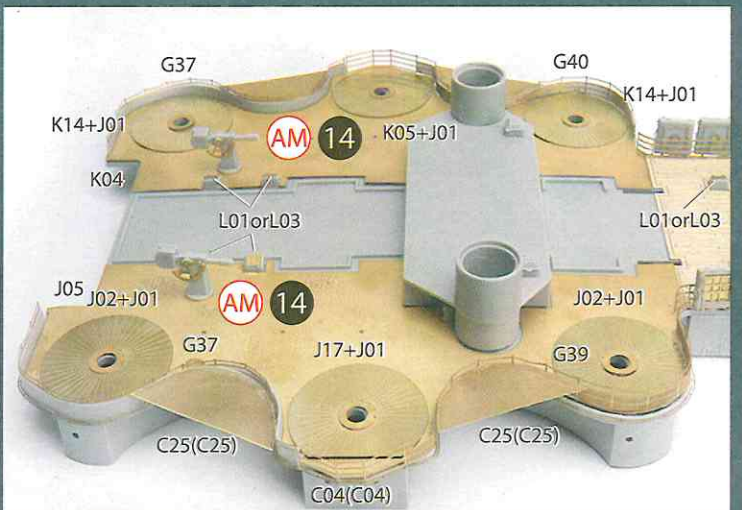
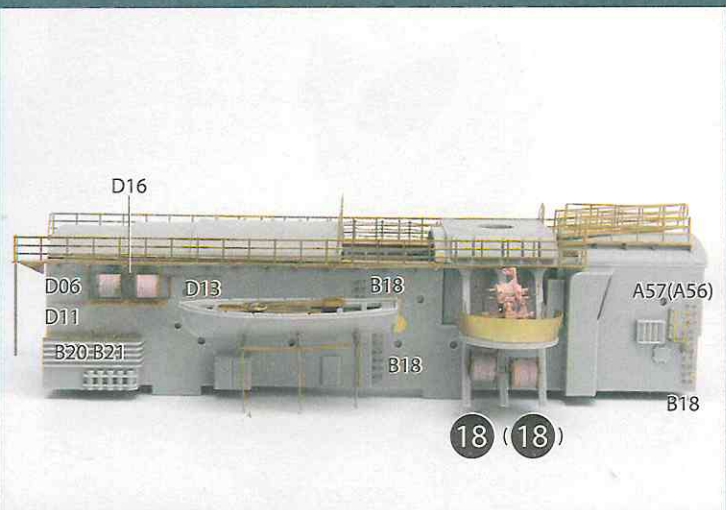
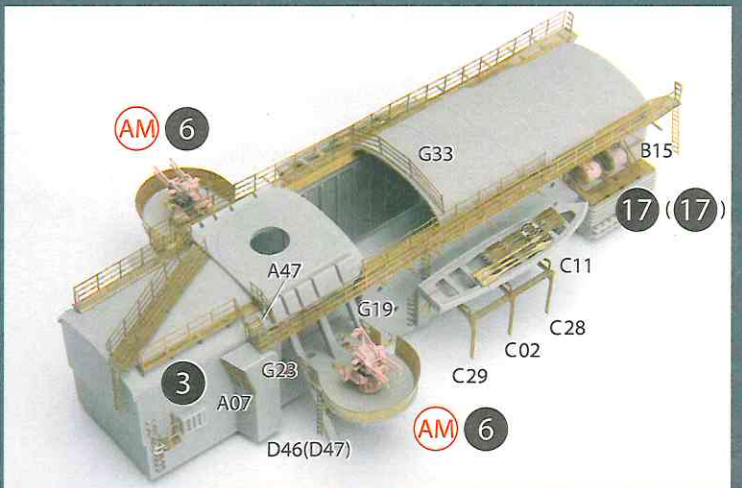
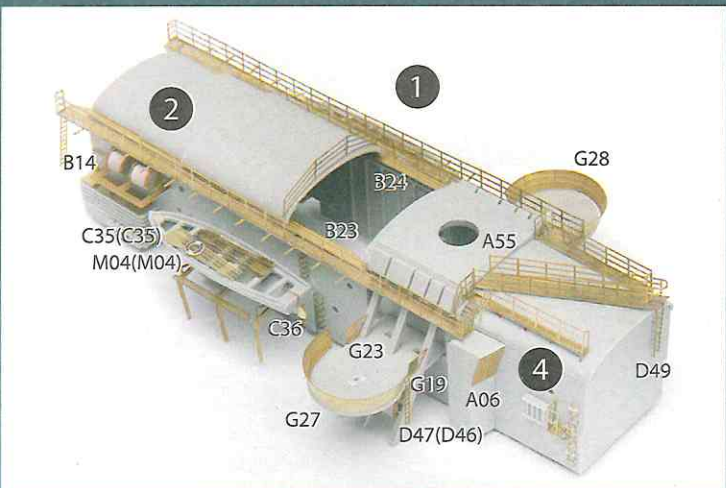
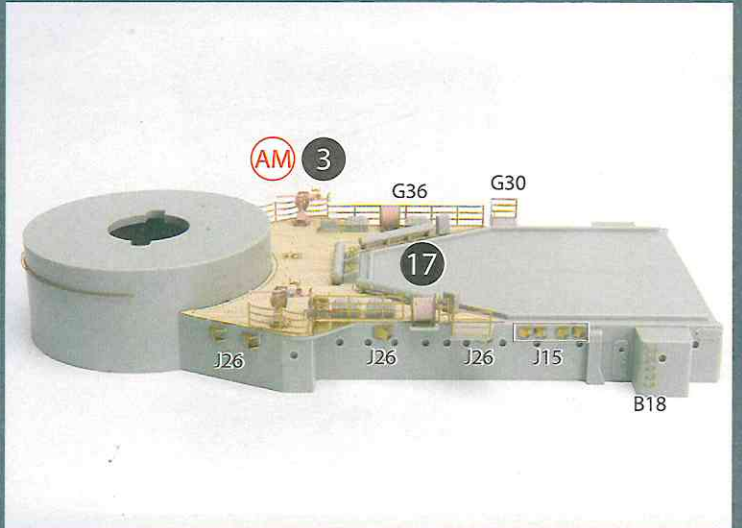
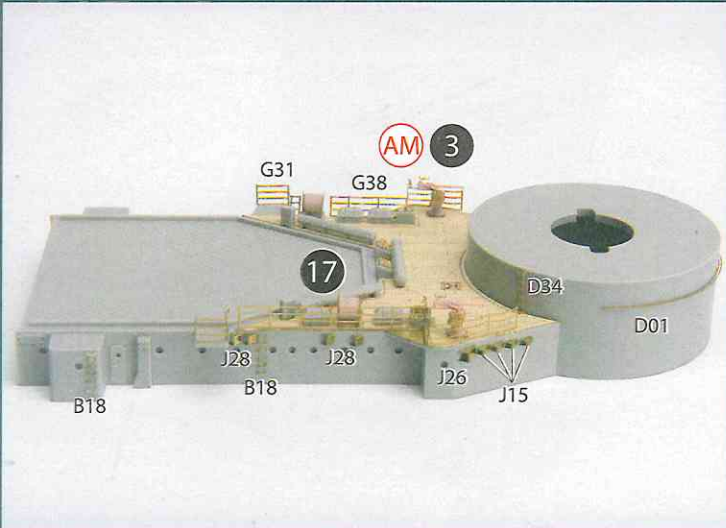
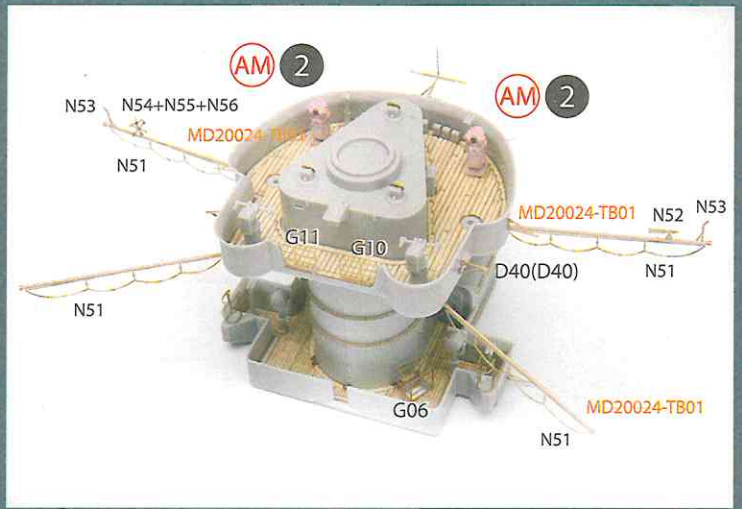
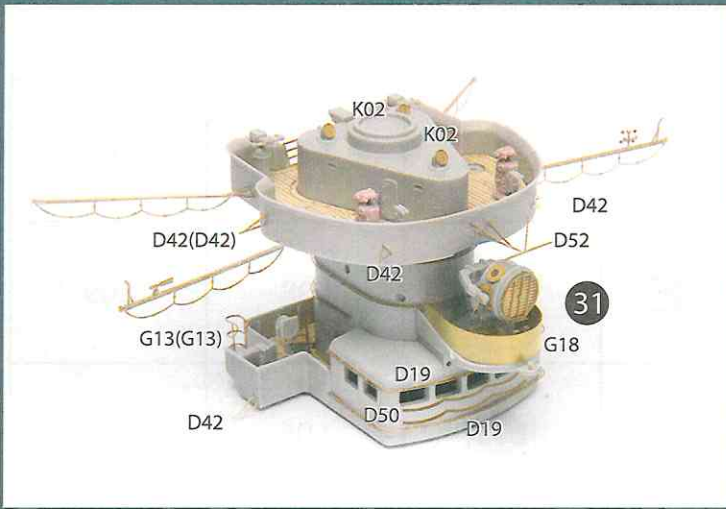

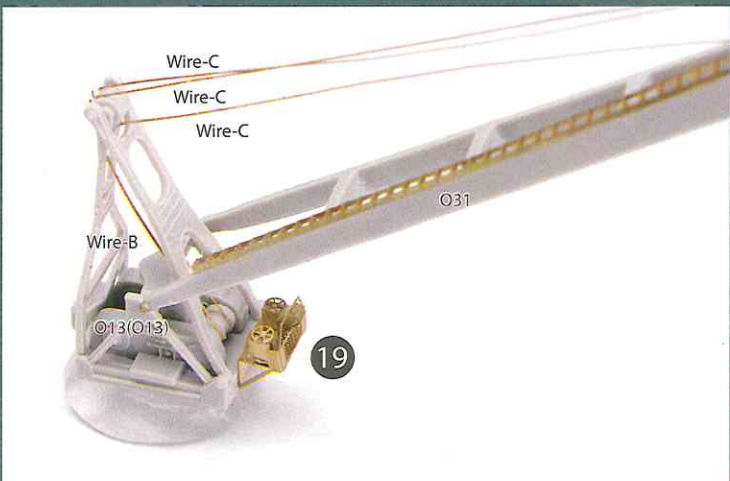
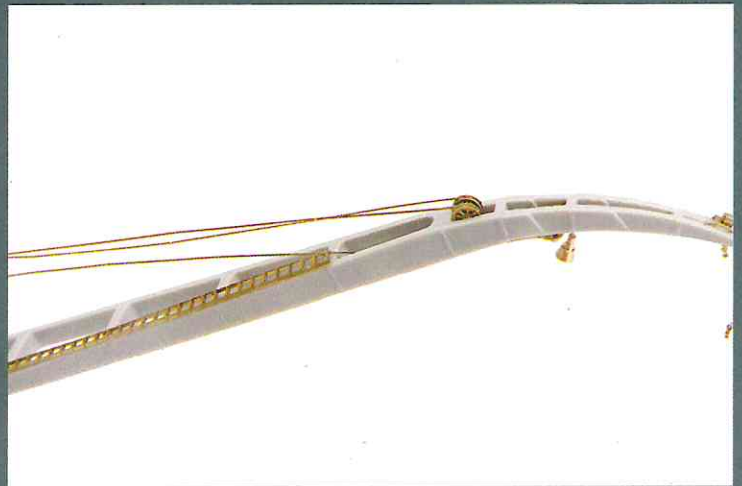
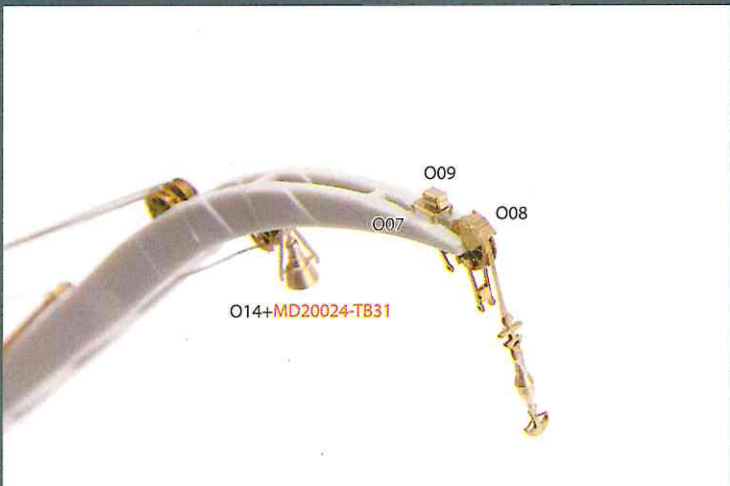
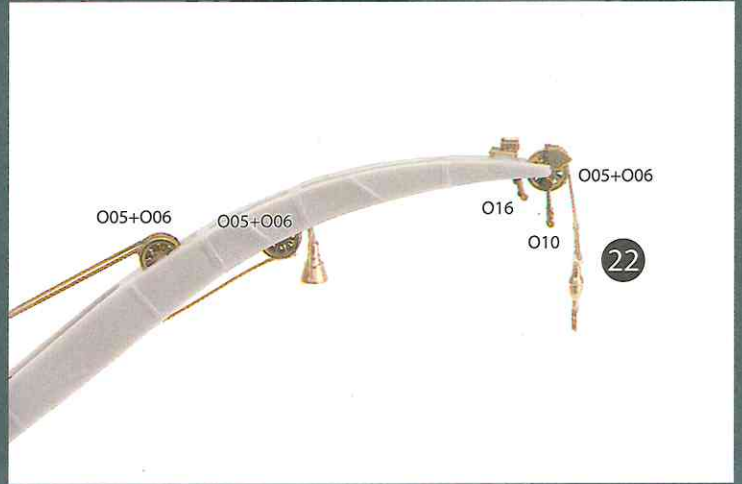
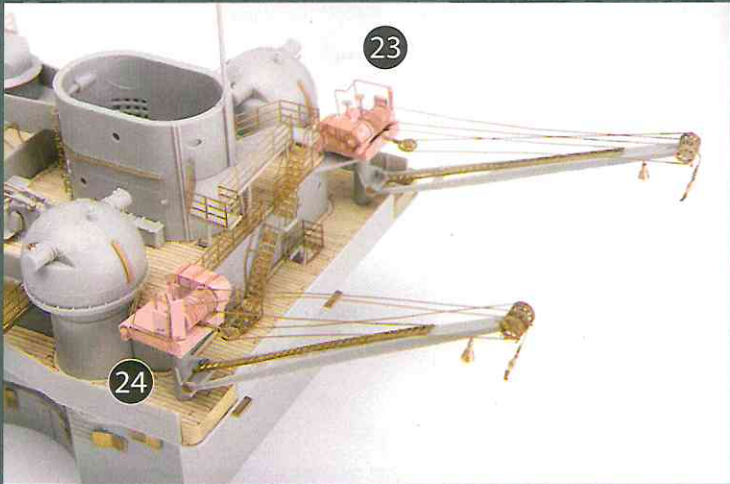
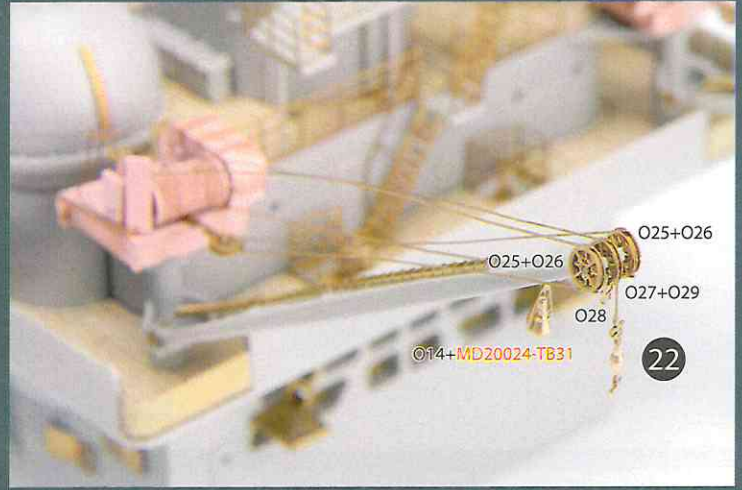
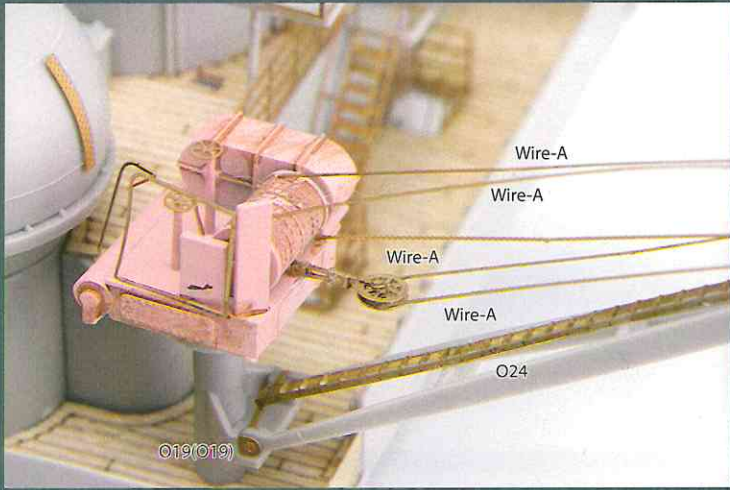

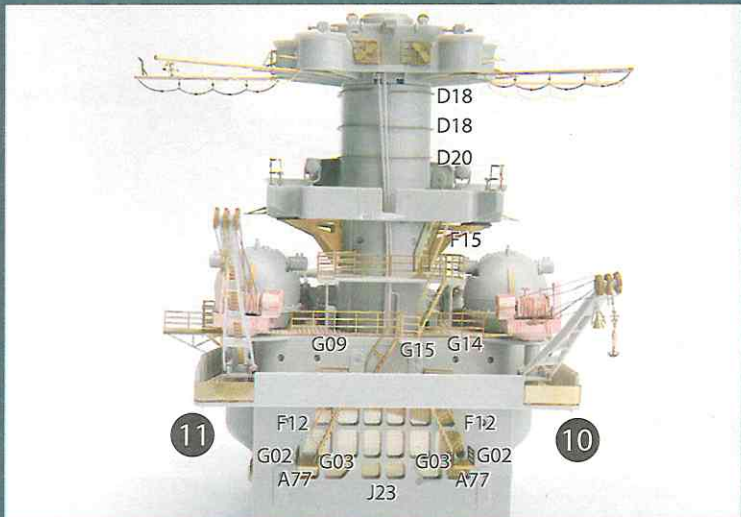
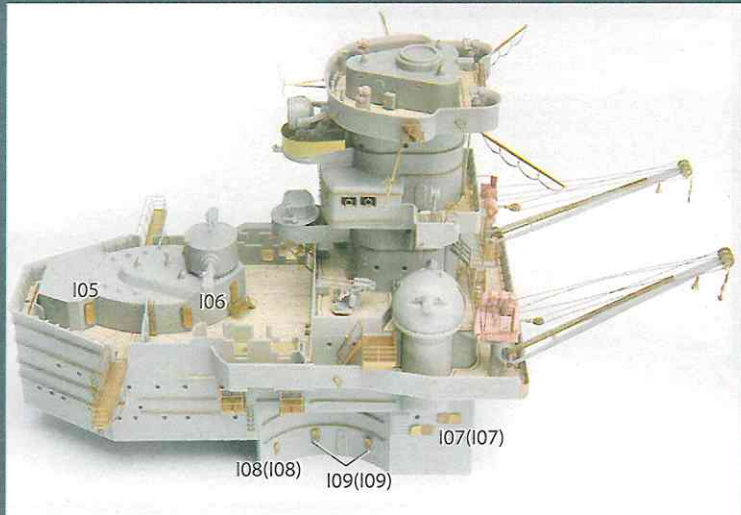
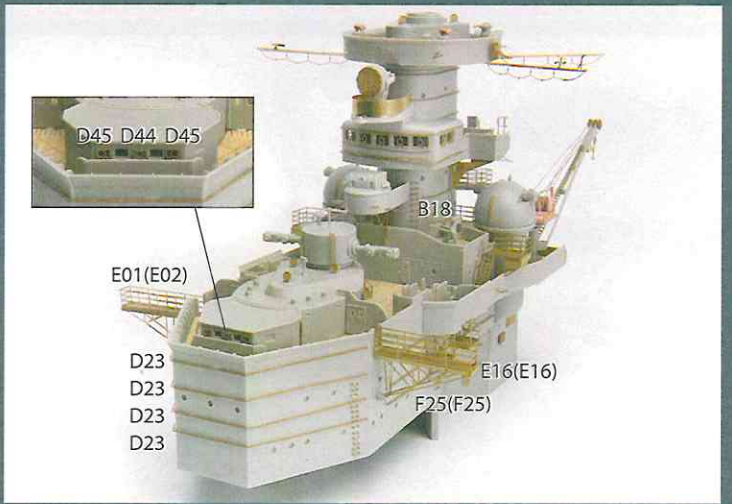
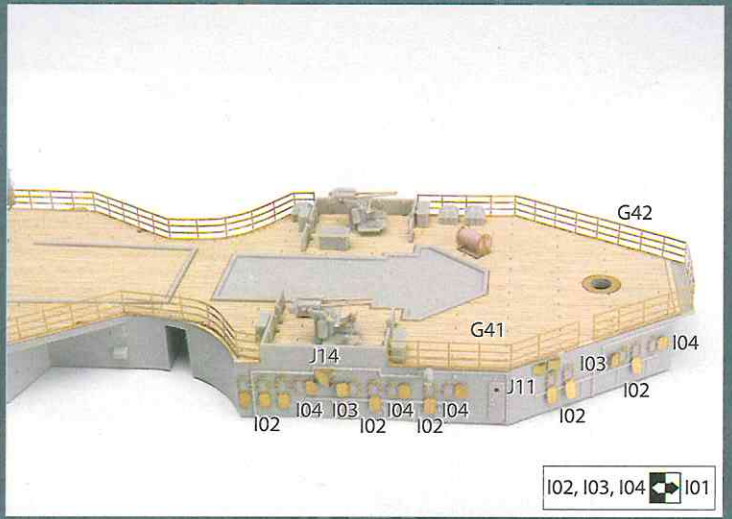
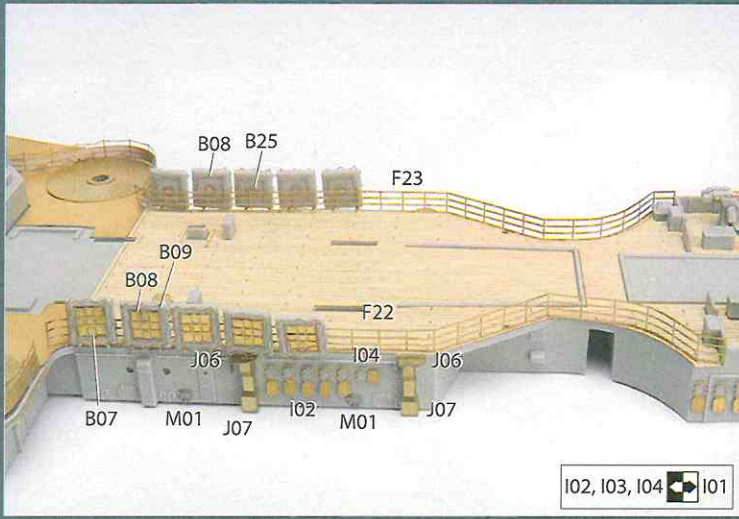

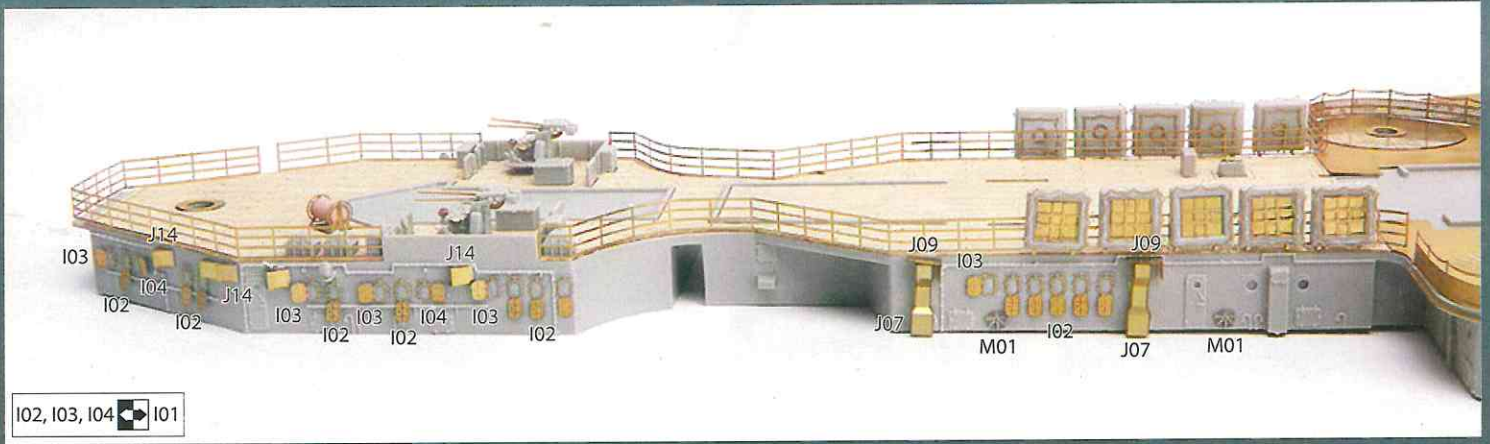

I02, I03, I04 I01

